

SERVICE MANUAL

RA-1 CHASSIS

<u>MODEL</u>	<u>COMMANDER</u>	<u>DEST.</u>	<u>CHASSIS NO.</u>
KP-41T15	RM-Y118	US	SCC-H53A-A
KP-41T15	RM-Y118	CND	SCC-H58A-A
KP-46S15	RM-Y118	US	SCC-H53B-A
KP-46S15	RM-Y118	CND	SCC-H58B-A

<u>MODEL</u>	<u>COMMANDER</u>	<u>DEST.</u>	<u>CHASSIS NO.</u>
KP-53S15	RM-Y118	US	SCC-H53C-A
KP-53S15	RM-Y118	CND	SCC-H58C-A

Note :

1. Adjustment Manual for this model is separately published.

	Adjustment Manual
Part No.	9-965-043-01



RM-Y118

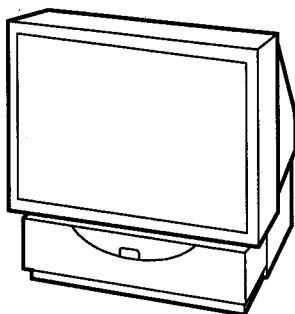

KP-41T15

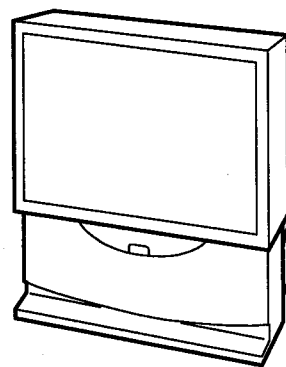

KP-46S15/53S15



COLOR REAR VIDEO PROJECTOR
SONY®

※ Please file according to model size.

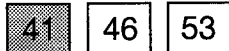

Les composants identifiés par une trame et une marque Δ sont critiques pour la sécurité. Ne les remplacer que par une pièce portant le numéro spécifique.

The components identified by shading and mark Δ are critical for safety. Replace only with part number specified.

D

REF. NO.	PART NO.	DESCRIPTION	REMARK	REF. NO.	PART NO.	DESCRIPTION	REMARK
<COIL>							
L1501	1-412-533-21	INDUCTOR 47UH		R1615	1-214-673-00	METAL 4.7 1% 1/4W	
L1502	1-412-533-21	INDUCTOR 47UH		R1616	1-214-673-00	METAL 4.7 1% 1/4W	
L1503	1-412-524-11	INDUCTOR 8.2UH		R1618	1-214-673-00	METAL 4.7 1% 1/4W	
L1515	1-410-470-11	INDUCTOR 10UH		R1619	1-214-673-00	METAL 4.7 1% 1/4W	
L1516	1-410-482-31	INDUCTOR 100UH		R1620	1-214-673-00	METAL 4.7 1% 1/4W	
L1701	1-410-470-11	INDUCTOR 10UH		R1621	1-214-673-00	METAL 4.7 1% 1/4W	
L1801	1-406-975-21	COIL, CHOKE 47UH		R1622	1-214-673-00	METAL 4.7 1% 1/4W	
L1802	1-406-975-21	COIL, CHOKE 47UH		R1623	1-214-729-00	METAL 1K 1% 1/4W	
<TRANSISTOR>							
Q1501	8-729-120-28	TRANSISTOR 2SC1623-L5L6		R1624	1-214-729-00	METAL 1K 1% 1/4W	
Q1502	8-729-120-28	TRANSISTOR 2SC1623-L5L6		R1625	1-214-673-00	METAL 4.7 1% 1/4W	
Q1551	8-729-216-22	TRANSISTOR 2SA1162-G		R1626	1-214-673-00	METAL 4.7 1% 1/4W	
Q1552	8-729-120-28	TRANSISTOR 2SC1623-L5L6		R1627	1-214-673-00	METAL 4.7 1% 1/4W	
Q1701	8-729-120-28	TRANSISTOR 2SC1623-L5L6		R1628	1-214-673-00	METAL 4.7 1% 1/4W	
Q1801	8-729-120-28	TRANSISTOR 2SC1623-L5L6		R1629	1-214-673-00	METAL 4.7 1% 1/4W	
Q1802	8-729-216-22	TRANSISTOR 2SA1162-G		R1630	1-214-673-00	METAL 4.7 1% 1/4W	
Q1803	8-729-900-36	TRANSISTOR DTC124ES		R1631	1-214-729-00	METAL 1K 1% 1/4W	
Q1804	8-729-120-28	TRANSISTOR 2SC1623-L5L6		R1632	1-214-673-00	METAL 4.7 1% 1/4W	
Q1805	8-729-900-36	TRANSISTOR DTC124ES		R1633	1-214-673-00	METAL 4.7 1% 1/4W	
<RESISTOR>							
R1501	1-216-049-00	METAL GLAZE 1K 5% 1/10W		R1634	1-214-729-00	METAL 1K 1% 1/4W	
R1502	1-208-814-11	METAL CHIP 22K 0.50% 1/10W		R1635	1-214-673-00	METAL 4.7 1% 1/4W	
R1504	1-216-081-00	METAL GLAZE 22K 5% 1/10W		R1636	1-214-673-00	METAL 4.7 1% 1/4W	
R1505	1-216-085-00	METAL GLAZE 33K 5% 1/10W		R1637	1-214-673-00	METAL 4.7 1% 1/4W	
R1506	1-216-049-00	METAL GLAZE 1K 5% 1/10W		R1638	1-214-673-00	METAL 4.7 1% 1/4W	
R1507	1-208-814-11	METAL CHIP 22K 0.50% 1/10W		R1639	1-214-673-00	METAL 4.7 1% 1/4W	
R1508	1-216-057-00	METAL GLAZE 2.2K 5% 1/10W		R1640	1-214-673-00	METAL 4.7 1% 1/4W	
R1509A	1-249-383-91	CARBON 1.5 5% 1/4W F		R1641	1-214-673-00	METAL 4.7 1% 1/4W	
R1510	1-214-671-91	METAL 3.9 1% 1/4W		R1642	1-214-673-00	METAL 4.7 1% 1/4W	
R1511	1-214-671-71	METAL 3.9 1% 1/4W		R1643A	1-202-967-91	FUSIBLE 0.1 10% 1/6W	
R1512	1-215-914-11	METAL OXIDE 330 5% 3W F		R1644A	1-202-967-91	FUSIBLE 0.1 10% 1/6W	
R1513	1-214-671-71	METAL 3.9 1% 1/4W		R1645A	1-202-967-91	FUSIBLE 0.1 10% 1/6W	
R1514	1-216-632-11	METAL CHIP 160 0.50% 1/10W		R1646A	1-202-967-91	FUSIBLE 0.1 10% 1/6W	
R1515	1-216-639-11	METAL CHIP 330 0.50% 1/10W		R1647A	1-202-967-91	FUSIBLE 0.1 10% 1/6W	
R1516	1-214-671-71	METAL 3.9 1% 1/4W		R1648A	1-202-967-91	FUSIBLE 0.1 10% 1/6W	
R1517	1-216-647-11	METAL CHIP 680 0.50% 1/10W		R1717	1-216-033-00	METAL GLAZE 220 5% 1/10W	
R1518	1-216-665-11	METAL CHIP 3.9K 0.50% 1/10W		R1721	1-216-033-00	METAL GLAZE 220 5% 1/10W	
R1519A	1-249-385-91	CARBON 2.2 5% 1/4W F		R1737	1-216-033-00	METAL GLAZE 220 5% 1/10W	
R1520A	1-249-385-91	CARBON 2.2 5% 1/4W F		R1740	1-216-025-00	METAL GLAZE 100 5% 1/10W	
R1521	1-216-049-00	METAL GLAZE 1K 5% 1/10W		R1748	1-216-033-00	METAL GLAZE 220 5% 1/10W	
R1522	1-216-049-00	METAL GLAZE 1K 5% 1/10W		R1749	1-216-295-00	CONDUCTOR, CHIP	
R1523	1-216-033-00	METAL GLAZE 220 5% 1/10W		R1751	1-216-081-00	METAL GLAZE 22K 5% 1/10W	
R1551	1-216-081-00	METAL GLAZE 22K 5% 1/10W		R1752	1-216-073-00	METAL GLAZE 10K 5% 1/10W	
R1552	1-216-063-00	METAL GLAZE 3.9K 5% 1/10W		R1760	1-216-295-00	CONDUCTOR, CHIP	
R1553	1-216-077-00	METAL GLAZE 15K 5% 1/10W		R1788	1-208-806-11	METAL CHIP 10K 0.50% 1/10W	
R1554	1-216-049-00	METAL GLAZE 1K 5% 1/10W		R1801	1-216-049-00	METAL GLAZE 1K 5% 1/10W	
R1559	1-216-073-00	METAL GLAZE 10K 5% 1/10W		R1802	1-216-049-00	METAL GLAZE 1K 5% 1/10W	
R1562	1-216-025-00	METAL GLAZE 100 5% 1/10W		R1803	1-216-073-00	METAL GLAZE 10K 5% 1/10W	
R1603	1-216-663-11	METAL CHIP 3.3K 0.50% 1/10W		R1804	1-216-057-00	METAL GLAZE 2.2K 5% 1/10W	
R1604	1-216-663-11	METAL CHIP 3.3K 0.50% 1/10W		R1805	1-216-069-00	METAL GLAZE 6.8K 5% 1/10W	
R1605	1-216-663-11	METAL CHIP 3.3K 0.50% 1/10W		R1806	1-216-081-00	METAL GLAZE 22K 5% 1/10W	
R1606	1-216-663-11	METAL CHIP 3.3K 0.50% 1/10W		R1807	1-216-075-00	METAL GLAZE 12K 5% 1/10W	
R1607	1-216-663-11	METAL CHIP 3.3K 0.50% 1/10W		R1808	1-216-049-00	METAL GLAZE 1K 5% 1/10W	
R1608	1-216-663-11	METAL CHIP 3.3K 0.50% 1/10W		R1809	1-216-081-00	METAL GLAZE 22K 5% 1/10W	
R1610	1-214-729-00	METAL 1K 1% 1/4W		R1810	1-216-097-00	METAL GLAZE 100K 5% 1/10W	
R1612	1-214-729-00	METAL 1K 1% 1/4W		R1811	1-216-081-00	METAL GLAZE 22K 5% 1/10W	
R1613	1-214-673-00	METAL 4.7 1% 1/4W		R1812	1-216-097-00	METAL GLAZE 100K 5% 1/10W	
				R1813	1-216-057-00	METAL GLAZE 2.2K 5% 1/10W	
				R1814	1-216-699-11	METAL CHIP 100K 0.50% 1/10W	
				R1815	1-216-697-91	METAL CHIP 82K 0.50% 1/10W	
				R1816	1-216-097-00	METAL GLAZE 100K 5% 1/10W	
				R1817	1-216-033-00	METAL GLAZE 220 5% 1/10W	
				R1818	1-216-025-00	METAL GLAZE 100 5% 1/10W	
				R1819	1-216-025-00	METAL GLAZE 100 5% 1/10W	
				R1820	1-216-025-00	METAL GLAZE 100 5% 1/10W	

The components identified by shading and mark Δ are critical for safety. Replace only with part number specified.

Les composants identifiés par une trame et une marque Δ sont critiques pour la sécurité. Ne les remplacer que par une pièce portant le numéro spécifié.



REF. NO.	PART NO.	DESCRIPTION	REMARK	REF. NO.	PART NO.	DESCRIPTION	REMARK
R1821	1-216-097-00	METAL GLAZE	100K 5% 1/10W	R1888	1-216-651-11	METAL CHIP	1K 0.50% 1/10W
R1823	1-208-811-11	METAL CHIP	16K 0.50% 1/10W	R1889	1-216-651-11	METAL CHIP	1K 0.50% 1/10W
R1824	1-216-685-11	METAL CHIP	27K 0.50% 1/10W	R1890	1-216-125-00	METAL GLAZE	1.5M 5% 1/10W
R1825	1-216-685-11	METAL CHIP	27K 0.50% 1/10W	R1891	1-208-806-11	METAL CHIP	10K 0.50% 1/10W
R1826	1-216-685-11	METAL CHIP	27K 0.50% 1/10W	R1892	1-216-067-00	METAL GLAZE	5.6K 5% 1/10W
R1827	1-216-685-11	METAL CHIP	27K 0.50% 1/10W	R1893	1-216-097-00	METAL GLAZE	100K 5% 1/10W
R1828	1-216-685-11	METAL CHIP	27K 0.50% 1/10W	R1894	1-216-043-91	METAL GLAZE	560 5% 1/10W
R1829	1-216-685-11	METAL CHIP	27K 0.50% 1/10W	R1895	1-216-043-91	METAL GLAZE	560 5% 1/10W
R1830	1-216-025-00	METAL GLAZE	100 5% 1/10W	R1896	1-216-043-91	METAL GLAZE	560 5% 1/10W
R1831	1-216-049-00	METAL GLAZE	1K 5% 1/10W	R1897	1-216-097-00	METAL GLAZE	100K 5% 1/10W
R1832	1-216-677-11	METAL CHIP	12K 0.50% 1/10W	R1898	1-216-057-00	METAL GLAZE	2.2K 5% 1/10W
R1833	1-216-049-00	METAL GLAZE	1K 5% 1/10W	R1899	1-216-097-00	METAL GLAZE	100K 5% 1/10W
R1834	1-216-049-00	METAL GLAZE	1K 5% 1/10W	R1900	1-216-033-00	METAL GLAZE	220 5% 1/10W
R1835	1-216-025-00	METAL GLAZE	100 5% 1/10W	R1901	1-216-025-00	METAL GLAZE	100 5% 1/10W
R1836	1-216-081-00	METAL GLAZE	22K 5% 1/10W	R1902	1-216-025-00	METAL GLAZE	100 5% 1/10W
R1837	1-208-806-11	METAL CHIP	10K 0.50% 1/10W	R1903	1-216-025-00	METAL GLAZE	100 5% 1/10W
R1838	1-216-651-11	METAL CHIP	1K 0.50% 1/10W	R1904	1-216-025-00	METAL GLAZE	100 5% 1/10W
R1839	1-216-031-00	METAL GLAZE	180 5% 1/10W	R1905	1-216-097-00	METAL GLAZE	100K 5% 1/10W
R1840	1-208-806-11	METAL CHIP	10K 0.50% 1/10W	R1907	1-208-810-11	METAL CHIP	15K 0.50% 1/10W
R1841	1-208-806-11	METAL CHIP	10K 0.50% 1/10W	R1908	1-208-814-11	METAL CHIP	22K 0.50% 1/10W
R1842	1-216-025-00	METAL GLAZE	100 5% 1/10W	R1909	1-216-025-00	METAL GLAZE	100 5% 1/10W
R1843	1-216-651-11	METAL CHIP	1K 0.50% 1/10W	R1910	1-216-685-11	METAL CHIP	27K 0.50% 1/10W
R1844	1-216-025-00	METAL GLAZE	100 5% 1/10W	R1911	1-216-685-11	METAL CHIP	27K 0.50% 1/10W
R1845	1-216-077-00	METAL GLAZE	15K 5% 1/10W	R1912	1-216-685-11	METAL CHIP	27K 0.50% 1/10W
R1846	1-216-125-00	METAL GLAZE	1.5M 5% 1/10W	R1913	1-216-685-11	METAL CHIP	27K 0.50% 1/10W
R1847	1-208-806-11	METAL CHIP	10K 0.50% 1/10W	R1914	1-216-685-11	METAL CHIP	27K 0.50% 1/10W
R1848	1-216-077-00	METAL GLAZE	15K 5% 1/10W	R1915	1-216-685-11	METAL CHIP	27K 0.50% 1/10W
R1849	1-216-067-00	METAL GLAZE	5.6K 5% 1/10W	R1916	1-216-025-00	METAL GLAZE	100 5% 1/10W
R1850	1-216-097-00	METAL GLAZE	100K 5% 1/10W	R1917	1-208-806-11	METAL CHIP	10K 0.50% 1/10W
R1851	1-216-043-91	METAL GLAZE	560 5% 1/10W	R1918	1-216-651-11	METAL CHIP	1K 0.50% 1/10W
R1852	1-216-097-00	METAL GLAZE	100K 5% 1/10W	R1919	1-208-822-11	METAL CHIP	47K 0.50% 1/10W
R1853	1-216-057-00	METAL GLAZE	2.2K 5% 1/10W	R1920	1-216-651-11	METAL CHIP	1K 0.50% 1/10W
R1854	1-216-025-00	METAL GLAZE	100 5% 1/10W	R1923	1-216-677-11	METAL CHIP	12K 0.50% 1/10W
R1855	1-216-097-00	METAL GLAZE	100K 5% 1/10W	R1925	1-216-031-00	METAL GLAZE	180 5% 1/10W
R1856	1-216-025-00	METAL GLAZE	100 5% 1/10W	R1926	1-208-806-11	METAL CHIP	10K 0.50% 1/10W
R1857	1-216-033-00	METAL GLAZE	220 5% 1/10W	R1927	1-216-125-00	METAL GLAZE	1.5M 5% 1/10W
R1858	1-216-097-00	METAL GLAZE	100K 5% 1/10W	R1928	1-208-806-11	METAL CHIP	10K 0.50% 1/10W
R1859	1-216-025-00	METAL GLAZE	100 5% 1/10W	R1931	1-216-698-11	METAL CHIP	91K 0.50% 1/10W
R1860	1-216-025-00	METAL GLAZE	100 5% 1/10W	R1935	1-218-766-11	METAL CHIP	390K 0.50% 1/10W
R1861	1-216-473-11	METAL OXIDE	56 5% 3W F	R1937	1-208-806-11	METAL CHIP	10K 0.50% 1/10W
R1862	1-216-473-11	METAL OXIDE	56 5% 3W F	R1938	1-208-810-11	METAL CHIP	15K 0.50% 1/10W
R1863	1-216-025-00	METAL GLAZE	100 5% 1/10W	R1940	1-208-812-11	METAL CHIP	18K 0.50% 1/10W
R1864	1-216-025-00	METAL GLAZE	100 5% 1/10W	R1941	1-208-806-11	METAL CHIP	10K 0.50% 1/10W
R1865	1-216-473-11	METAL OXIDE	56 5% 3W F	R1942	1-208-806-11	METAL CHIP	10K 0.50% 1/10W
R1866	1-216-473-11	METAL OXIDE	56 5% 3W F	R1943	1-216-699-11	METAL CHIP	100K 0.50% 1/10W
R1868	1-216-025-00	METAL GLAZE	100 5% 1/10W	R1944	1-208-806-11	METAL CHIP	10K 0.50% 1/10W
R1869	1-216-685-11	METAL CHIP	27K 0.50% 1/10W	R1947	1-216-073-00	METAL GLAZE	10K 5% 1/10W
R1870	1-216-685-11	METAL CHIP	27K 0.50% 1/10W	R1948	1-216-093-00	METAL GLAZE	68K 5% 1/10W
R1871	1-216-685-11	METAL CHIP	27K 0.50% 1/10W	R1949	1-216-659-11	METAL CHIP	2.2K 0.50% 1/10W
R1872	1-216-685-11	METAL CHIP	27K 0.50% 1/10W	R1950	1-216-659-11	METAL CHIP	2.2K 0.50% 1/10W
R1873	1-216-685-11	METAL CHIP	27K 0.50% 1/10W	R1951	1-208-806-11	METAL CHIP	10K 0.50% 1/10W
R1874	1-216-685-11	METAL CHIP	27K 0.50% 1/10W	R1952	1-208-806-11	METAL CHIP	10K 0.50% 1/10W
R1875	1-208-824-11	METAL CHIP	56K 0.50% 1/10W	R1954	1-208-806-11	METAL CHIP	10K 0.50% 1/10W
R1876	1-216-025-00	METAL GLAZE	100 5% 1/10W	R1955	1-208-806-11	METAL CHIP	10K 0.50% 1/10W
R1877	1-208-810-11	METAL CHIP	15K 0.50% 1/10W	R1956	1-208-800-11	METAL CHIP	5.6K 0.50% 1/10W
R1878	1-208-806-11	METAL CHIP	10K 0.50% 1/10W	R1957	1-208-824-11	METAL CHIP	56K 0.50% 1/10W
R1879	1-216-685-11	METAL CHIP	27K 0.50% 1/10W	R1958	1-208-800-11	METAL CHIP	5.6K 0.50% 1/10W
R1880	1-218-768-11	METAL CHIP	470K 0.50% 1/10W	R1959	1-208-824-11	METAL CHIP	56K 0.50% 1/10W
R1881	1-216-295-00	CONDUCTOR, CHIP		R1960	1-208-806-11	METAL CHIP	10K 0.50% 1/10W
R1883	1-216-677-11	METAL CHIP	12K 0.50% 1/10W	R1961	1-208-806-11	METAL CHIP	10K 0.50% 1/10W
R1884	1-208-806-11	METAL CHIP	10K 0.50% 1/10W	R1962	1-216-077-00	METAL GLAZE	15K 5% 1/10W
R1885	1-216-049-00	METAL GLAZE	1K 5% 1/10W	R1963	1-216-073-00	METAL GLAZE	10K 5% 1/10W
R1886	1-216-031-00	METAL GLAZE	180 5% 1/10W	R1964	1-216-049-00	METAL GLAZE	1K 5% 1/10W
R1887	1-208-806-11	METAL CHIP	10K 0.50% 1/10W				



REF. NO.	PART NO.	DESCRIPTION	REMARK	REF. NO.	PART NO.	DESCRIPTION	REMARK
R1965	1-216-073-00	METAL GLAZE	10K 5% 1/10W	S1301	1-571-731-11	SWITCH, TACTIL	
R1966	1-216-073-00	METAL GLAZE	10K 5% 1/10W	S1302	1-571-731-11	SWITCH, TACTIL	
R1967	1-216-071-00	METAL GLAZE	8.2K 5% 1/10W	S1303	1-571-731-11	SWITCH, TACTIL	
R1970	1-208-774-11	METAL CHIP	470 0.50% 1/10W	S1304	1-571-731-11	SWITCH, TACTIL	
R1971	1-216-667-11	METAL CHIP	4.7K 0.50% 1/10W	S1305	1-571-731-11	SWITCH, TACTIL	
R1981	1-216-473-11	METAL OXIDE	56 5% 3W F	S1306	1-571-731-11	SWITCH, TACTIL	
R1982	1-216-473-11	METAL OXIDE	56 5% 3W F	S1307	1-571-731-11	SWITCH, TACTIL	
R1983	1-216-077-00	METAL GLAZE	15K 5% 1/10W	*****			
R1984	1-216-077-00	METAL GLAZE	15K 5% 1/10W	*A-1373-511-A	U BOARD, COMPLETE		
R1985	1-216-025-00	METAL GLAZE	100 5% 1/10W		*****		
<THERMISTOR>				1-923-505-16	WIRE UL1007 AWG24 70MM BRN		
TH1501	1-807-925-11	THERMISTOR		<CAPACITOR>			
TH1801	1-808-269-11	THERMISTOR		C1101	1-128-551-11	ELECT 22MF	20% 50V
<CRYSTAL>				C1102	1-124-903-11	ELECT 1MF	20% 50V
X1701	1-579-917-11	VIBRATOR, CRYSTAL		C1103	1-124-903-11	ELECT 1MF	20% 50V
*****				C1104	1-163-031-11	CERAMIC CHIP 0.01MF	50V
*A-1372-099-A	HA BOARD, COMPLETE			C1105	1-128-551-11	ELECT 22MF	20% 50V
	*****			C1106	1-128-551-11	ELECT 22MF	20% 50V
<CAPACITOR>				C1107	1-124-903-11	ELECT 1MF	20% 50V
C1301	1-126-964-11	ELECT 10MF	20% 50V	C1108	1-124-903-11	ELECT 1MF	20% 50V
C1304	1-126-964-11	ELECT 10MF	20% 50V	C1109	1-128-551-11	ELECT 22MF	20% 50V
<CONNECTOR>				C1110	1-124-903-11	ELECT 1MF	20% 50V
CN1346	1-564-524-11	PLUG, CONNECTOR 9P		C1111	1-124-903-11	ELECT 1MF	20% 50V
CN1347*1-564-521-11	PLUG, CONNECTOR 6P			C1121	1-126-935-11	ELECT 470MF	20% 16V
<DIODE>				C1122	1-163-117-00	CERAMIC CHIP 100PF	5% 50V
D1304	8-719-053-43	DIODE SLR-325VCT31		C1123	1-124-903-11	ELECT 1MF	20% 50V
D1305	8-719-053-43	DIODE SLR-325VCT31		C1124	1-128-551-11	ELECT 22MF	20% 50V
<IC>				C1125	1-124-903-11	ELECT 1MF	20% 50V
IC1301	8-741-780-51	IC SBX1780-51		C1126	1-104-665-11	ELECT 100MF	20% 25V
<JACK>				C1127	1-104-663-11	ELECT 33MF	20% 25V
J1301	1-750-517-11	JACK BLOCK, PIN 3P		C1128	1-163-117-00	CERAMIC CHIP 100PF	5% 50V
<RESISTOR>				C1132	1-124-902-00	ELECT 0.47MF	20% 50V
R1302	1-249-416-11	CARBON 820 5%	1/4W	C1133	1-128-551-11	ELECT 22MF	20% 50V
R1303	1-249-417-11	CARBON 1K 5%	1/4W	C1134	1-104-665-11	ELECT 100MF	20% 25V
R1304	1-249-425-11	CARBON 4.7K 5%	1/4W	C1136	1-128-551-11	ELECT 22MF	20% 50V
R1305	1-249-411-11	CARBON 330 5%	1/4W	C1137	1-164-232-11	CERAMIC CHIP 0.01MF	10% 50V
R1306	1-249-411-11	CARBON 330 5%	1/4W	C1138	1-124-902-00	ELECT 0.47MF	20% 50V
R1307	1-249-420-11	CARBON 1.8K 5%	1/4W	C1139	1-126-964-11	ELECT 10MF	20% 50V
R1308	1-247-895-00	CARBON 470K 5%	1/4W	C1145	1-128-499-11	ELECT 220MF	20% 16V
R1309	1-247-895-00	CARBON 470K 5%	1/4W	C1146	1-124-902-00	ELECT 0.47MF	20% 50V
R1310	1-249-429-11	CARBON 10K 5%	1/4W	C1147	1-124-902-00	ELECT 0.47MF	20% 50V
R1311	1-247-815-91	CARBON 220 5%	1/4W	C1148	1-124-902-00	ELECT 0.47MF	20% 50V
R1312	1-247-804-11	CARBON 75 5%	1/4W	C1149	1-124-902-00	ELECT 0.47MF	20% 50V
R1314	1-247-807-31	CARBON 100 5%	1/4W	C1150	1-128-499-11	ELECT 220MF	20% 16V
<SWITCH>				C1151	1-128-499-11	ELECT 220MF	20% 16V
				C1152	1-128-499-11	ELECT 220MF	20% 16V
				C1153	1-104-665-11	ELECT 100MF	20% 25V
				<FILTER BLOCK>			
				CM1101	1-466-912-21	FILTER BLOCK, COMB	
				<CONNECTOR>			
				CN1147*1-564-509-11	PLUG, CONNECTOR 6P		
				CN1150	1-573-300-21	CONNECTOR, BOARD TO BOARD 18P	
				CN1155*1-565-928-11	CONNECTOR (TUB) 30P		
				CN1156*1-566-641-11	CONNECTOR, HINGE (TAB) 18P		



REF. NO.	PART NO.	DESCRIPTION	REMARK	REF. NO.	PART NO.	DESCRIPTION	REMARK
<DIODE>				<RESISTOR>			
D1101	8-719-110-17	DIODE RD10ESB2		R1101	1-216-065-00	METAL GLAZE 4.7K 5%	1/10W
D1102	8-719-110-17	DIODE RD10ESB2		R1102	1-216-065-00	METAL GLAZE 4.7K 5%	1/10W
D1103	8-719-110-17	DIODE RD10ESB2		R1103	1-247-804-11	CARBON 75 5%	1/4W
D1104	8-719-110-17	DIODE RD10ESB2		R1104	1-216-065-00	METAL GLAZE 4.7K 5%	1/10W
D1105	8-719-110-17	DIODE RD10ESB2		R1105	1-247-804-11	CARBON 75 5%	1/4W
D1106	8-719-110-17	DIODE RD10ESB2		R1106	1-247-804-11	CARBON 75 5%	1/4W
D1107	8-719-110-17	DIODE RD10ESB2		R1107	1-216-113-00	METAL GLAZE 470K 5%	1/10W
D1108	8-719-110-17	DIODE RD10ESB2		R1108	1-216-065-00	METAL GLAZE 4.7K 5%	1/10W
D1109	8-719-110-17	DIODE RD10ESB2		R1109	1-216-113-00	METAL GLAZE 470K 5%	1/10W
D1111	8-719-110-17	DIODE RD10ESB2		R1110	1-216-065-00	METAL GLAZE 4.7K 5%	1/10W
D1112	8-719-110-17	DIODE RD10ESB2		R1111	1-216-065-00	METAL GLAZE 4.7K 5%	1/10W
D1113	8-719-110-17	DIODE RD10ESB2		R1112	1-216-065-00	METAL GLAZE 4.7K 5%	1/10W
D1114	8-719-110-17	DIODE RD10ESB2		R1113	1-247-804-11	CARBON 75 5%	1/4W
D1115	8-719-110-17	DIODE RD10ESB2		R1114	1-216-113-00	METAL GLAZE 470K 5%	1/10W
D1116	8-719-110-17	DIODE RD10ESB2		R1115	1-216-113-00	METAL GLAZE 470K 5%	1/10W
D1117	8-719-110-17	DIODE RD10ESB2		R1116	1-216-095-00	METAL GLAZE 82K 5%	1/10W
D1118	8-719-110-17	DIODE RD10ESB2		R1117	1-216-095-00	METAL GLAZE 82K 5%	1/10W
D1120	8-719-110-17	DIODE RD10ESB2		R1118	1-216-095-00	METAL GLAZE 82K 5%	1/10W
D1121	8-719-110-36	DIODE RD13ESB2		R1119	1-216-025-00	METAL GLAZE 100 5%	1/10W
D1122	8-719-110-36	DIODE RD13ESB2		R1120	1-216-025-00	METAL GLAZE 100 5%	1/10W
D1123	8-719-110-36	DIODE RD13ESB2		R1127	1-216-041-00	METAL GLAZE 470 5%	1/10W
D1124	8-719-110-36	DIODE RD13ESB2		R1129	1-216-041-00	METAL GLAZE 470 5%	1/10W
D1125	8-719-109-66	DIODE RD3.3ESB2		R1130	1-216-067-00	METAL GLAZE 5.6K 5%	1/10W
D1126	8-719-110-17	DIODE RD10ESB2		R1132	1-216-025-00	METAL GLAZE 100 5%	1/10W
D1127	8-719-110-17	DIODE RD10ESB2		R1133	1-216-067-00	METAL GLAZE 5.6K 5%	1/10W
D1135	8-719-911-19	DIODE ISS119-25		R1134	1-216-065-00	METAL GLAZE 4.7K 5%	1/10W
<IC>				R1140	1-216-025-00	METAL GLAZE 100 5%	1/10W
IC1101	8-752-068-46	IC CXA1855S		R1141	1-216-041-00	METAL GLAZE 470 5%	1/10W
IC1102	8-759-701-59	IC NJW7809FA		R1142	1-216-025-00	METAL GLAZE 100 5%	1/10W
<JACK>				R1145	1-216-051-00	METAL GLAZE 1.2K 5%	1/10W
J1101	1-750-515-11	TERMINAL BLOCK, S 3P		R1146	1-216-051-00	METAL GLAZE 1.2K 5%	1/10W
J1102	1-750-517-11	JACK BLOCK, PIN 3P		R1149	1-216-041-00	METAL GLAZE 470 5%	1/10W
J1104	1-750-517-11	JACK BLOCK, PIN 3P		R1150	1-216-025-00	METAL GLAZE 100 5%	1/10W
J1105	1-750-516-11	JACK BLOCK, PIN 2P		R1151	1-216-025-00	METAL GLAZE 100 5%	1/10W
J1106	1-563-760-11	JACK, MINIATURER (DIA. 3.5)		R1152	1-216-043-91	METAL GLAZE 560 5%	1/10W
J1107	1-563-760-11	JACK, MINIATURER (DIA. 3.5)		R1153	1-216-049-00	METAL GLAZE 1K 5%	1/10W
<COIL>				R1154	1-216-041-00	METAL GLAZE 470 5%	1/10W
L1101	1-410-476-11	INDUCTOR 33UH		R1155	1-216-049-00	METAL GLAZE 1K 5%	1/10W
L1104	1-410-473-11	INDUCTOR 18UH		R1156	1-216-043-91	METAL GLAZE 560 5%	1/10W
L1105	1-410-494-11	INDUCTOR 1MMH		R1157	1-216-045-00	METAL GLAZE 680 5%	1/10W
<TRANSISTOR>				R1160	1-216-049-00	METAL GLAZE 1K 5%	1/10W
Q1102	8-729-216-22	TRANSISTOR 2SA1162-G		R1161	1-216-041-00	METAL GLAZE 470 5%	1/10W
Q1103	8-729-216-22	TRANSISTOR 2SA1162-G		R1162	1-216-041-00	METAL GLAZE 470 5%	1/10W
Q1104	8-729-422-27	TRANSISTOR 2SD601A-Q		R1165	1-249-403-11	CARBON 68 5%	1/4W
Q1105	8-729-216-22	TRANSISTOR 2SA1162-G		R1166	1-216-113-00	METAL GLAZE 470K 5%	1/10W
Q1106	8-729-216-22	TRANSISTOR 2SA1162-G		R1167	1-216-113-00	METAL GLAZE 470K 5%	1/10W
Q1108	8-729-422-27	TRANSISTOR 2SD601A-Q		R1168	1-216-113-00	METAL GLAZE 470K 5%	1/10W
Q1109	8-729-216-22	TRANSISTOR 2SA1162-G		R1169	1-216-025-00	METAL GLAZE 100 5%	1/10W
Q1110	8-729-216-22	TRANSISTOR 2SA1162-G		R1170	1-216-041-00	METAL GLAZE 470 5%	1/10W
Q1111	8-729-216-22	TRANSISTOR 2SA1162-G		R1171	1-216-041-00	METAL GLAZE 470 5%	1/10W
Q1112	8-729-422-27	TRANSISTOR 2SD601A-Q		R1172	1-216-025-00	METAL GLAZE 100 5%	1/10W
Q1113	8-729-422-27	TRANSISTOR 2SD601A-Q		R1173	1-216-025-00	METAL GLAZE 100 5%	1/10W
Q1114	8-729-422-27	TRANSISTOR 2SD601A-Q		R1174	1-216-041-00	METAL GLAZE 470 5%	1/10W
Q1115	8-729-422-27	TRANSISTOR 2SD601A-Q		R1175	1-216-025-00	METAL GLAZE 100 5%	1/10W
				R1176	1-216-025-00	METAL GLAZE 100 5%	1/10W
				R1178	1-216-041-00	METAL GLAZE 470 5%	1/10W
				R1179	1-216-025-00	METAL GLAZE 100 5%	1/10W
				R1180	1-216-025-00	METAL GLAZE 100 5%	1/10W
				R1181	1-216-097-00	METAL GLAZE 100K 5%	1/10W
				R1182	1-216-113-00	METAL GLAZE 470K 5%	1/10W

U **ZR (KP-41T15)** **ZR (KP-46S15/53S15)** **ZG**

REF. NO.	PART NO.	DESCRIPTION	REMARK	REF. NO.	PART NO.	DESCRIPTION	REMARK
R1183	1-216-049-00	METAL GLAZE 1K 5%	1/10W	R1406	1-216-479-11	METAL OXIDE 560 5%	3W F
R1184	1-216-113-00	METAL GLAZE 470K 5%	1/10W	R1407	1-249-400-11	CARBON 39 5%	1/4W F
R1185	1-216-049-00	METAL GLAZE 1K 5%	1/10W	R1408	1-249-384-11	CARBON 1.8 5%	1/4W F
R1186	1-216-061-00	METAL GLAZE 3.3K 5%	1/10W	R1409	1-249-384-11	CARBON 1.8 5%	1/4W F
R1187	1-216-061-00	METAL GLAZE 3.3K 5%	1/10W	R1410	1-247-734-11	CARBON 39 5%	1/2W F
R1188	1-216-097-00	METAL GLAZE 100K 5%	1/10W	R1411	1-249-417-11	CARBON 1K 5%	1/4W F
R1190	1-216-295-00	CONDUCTOR, CHIP		R1412	1-249-414-11	CARBON 560 5%	1/4W
R1191	1-216-295-00	CONDUCTOR, CHIP		R1413	1-249-432-11	CARBON 18K 5%	1/4W
R1192	1-216-295-00	CONDUCTOR, CHIP		R1414	1-249-432-11	CARBON 18K 5%	1/4W
R1193	1-216-025-00	METAL GLAZE 100 5%	1/10W	R1415	1-249-414-11	CARBON 560 5%	1/4W F
R1194	1-216-025-00	METAL GLAZE 100 5%	1/10W	R1416	1-216-451-11	METAL OXIDE 120 5%	2W F
R1196	1-216-041-00	METAL GLAZE 470 5%	1/10W	R1417	1-216-475-11	METAL OXIDE 120 5%	3W F
R1197	1-216-041-00	METAL GLAZE 470 5%	1/10W	R1418	1-249-377-11	CARBON 0.47 5%	1/4W F
*****				R1419	1-247-815-91	CARBON 220 5%	1/4W
*A-1390-487-A ZR BOARD, COMPLETE (KP-41T15)				R1420	1-216-475-11	METAL OXIDE 120 5%	3W F
*****				*****			
4-382-854-11 SCREW (M3X10), P, SW (+)				*A-1390-513-A ZR BOARD, COMPLETE (KP-46S15/53S15)			
*****				*****			
<CAPACITOR>				4-382-854-11 SCREW (M3X10), P, SW (+)			
C1401	1-162-115-00	CERAMIC 330PF 10%	2KV	<CAPACITOR>			
C1402	1-162-115-00	CERAMIC 330PF 10%	2KV	C1401	1-162-115-00	CERAMIC 330PF 10%	2KV
C1403	1-102-978-00	CERAMIC 220PF 5%	50V	C1402	1-162-115-00	CERAMIC 330PF 10%	2KV
C1404	1-107-638-11	ELECT 33MF 20%	160V	<CONNECTOR>			
C1405	1-104-665-11	ELECT 100MF 20%	25V	CN1411*1-580-689-11	PIN, CONNECTOR (PC BOARD) 4P		
C1406	1-107-370-11	FILM 0.1MF 10%	200V	CN1412*1-564-507-11	PLUG, CONNECTOR 4P		
C1407	1-104-665-11	ELECT 100MF 20%	25V	CN1413*1-564-506-11	PLUG, CONNECTOR 3P		
C1408	1-107-362-11	FILM 0.0047MF 10%	200V	CN1415*1-564-506-11	PLUG, CONNECTOR 3P		
C1409	1-107-667-11	ELECT 2.2MF 20%	160V	<RESISTOR>			
C1410	1-107-362-11	FILM 0.0047MF 10%	200V	R1401	1-249-414-11	CARBON 560 5%	1/4W
C1411	1-137-364-11	FILM 0.001MF 5%	50V	R1402	1-249-414-11	CARBON 560 5%	1/4W
C1412	1-137-364-11	FILM 0.001MF 5%	50V	R1403	1-202-822-00	SOLID 2.2K 20%	1/2W
C1413	1-161-830-00	CERAMIC 0.0047MF 99%	500V	R1404	1-202-822-00	SOLID 2.2K 20%	1/2W
C1414	1-126-940-11	ELECT 330MF 20%	16V	R1417	1-216-475-11	METAL OXIDE 120 5%	3W F
C1415	1-164-046-11	CERAMIC 10PF 0.5PF	50V	R1420	1-216-475-11	METAL OXIDE 120 5%	3W F
C1416	1-102-973-00	CERAMIC 100PF 5%	50V	*****			
<CONNECTOR>				*A-1390-489-A ZG BOARD, COMPLETE (KP-41T15)			
CN1411*1-580-689-11 PIN, CONNECTOR (PC BOARD) 4P				*****			
CN1412*1-564-507-11 PLUG, CONNECTOR 4P				*A-1390-512-A ZG BOARD, COMPLETE (KP-46S15/53S15)			
CN1413*1-564-506-11 PLUG, CONNECTOR 3P				*****			
CN1414*1-564-509-11 PLUG, CONNECTOR 6P				<CAPACITOR>			
CN1415*1-564-510-11 PLUG, CONNECTOR 7P				C1431 1-162-115-00 CERAMIC 330PF 10% 2KV			
<DIODE>				C1432 1-162-115-00 CERAMIC 330PF 10% 2KV			
D1401	8-719-110-88	DIODE RD39ESB2		C1433 1-102-973-00 CERAMIC 100PF 5% 50V			
D1402	8-719-110-88	DIODE RD39ESB2		(KP-41T15)			
<TRANSISTOR>				<CONNECTOR>			
Q1401	8-729-017-06	TRANSISTOR 2SC4793		CN1441*1-580-689-11 PIN, CONNECTOR (PC BOARD) 4P			
Q1402	8-729-017-05	TRANSISTOR 2SA1837		CN1442*1-564-507-11 PLUG, CONNECTOR 4P			
Q1403	8-729-140-96	TRANSISTOR 2SD774-34		CN1443*1-564-506-11 PLUG, CONNECTOR 3P			
<RESISTOR>				CN1445*1-564-506-11 PLUG, CONNECTOR 3P (KP-46S15/53S15)			
R1401	1-249-414-11	CARBON 560 5%	1/4W				
R1402	1-249-414-11	CARBON 560 5%	1/4W				
R1403	1-202-822-00	SOLID 2.2K 20%	1/2W				
R1404	1-202-822-00	SOLID 2.2K 20%	1/2W				
R1405	1-249-417-11	CARBON 1K 5%	1/4W				

The components identified by shading and mark Δ are critical for safety. Replace only with part number specified.

Les composants identifiés par une trame et une marque Δ sont critiques pour la sécurité. Ne les remplacer que par une pièce portant le numéro spécifié.



REF. NO. PART NO. DESCRIPTION REMARK

REF. NO. PART NO. DESCRIPTION REMARK

CN1445*1-564-510-11 PLUG, CONNECTOR 7P (KP-41T15)

<RESISTOR>

R1431	1-249-414-11	CARBON	560	5%	1/4W	
R1432	1-249-414-11	CARBON	560	5%	1/4W	
R1433	1-202-822-00	SOLID	2.2K	20%	1/2W	
R1434	1-202-822-00	SOLID	2.2K	20%	1/2W	
R1435	1-216-475-11	METAL OXIDE	120	5%	3W	F
R1436	1-216-475-11	METAL OXIDE	120	5%	3W	F
R1437	1-249-417-11	CARBON	1K	5%	1/4W	

(KP-41T15)

*A-1390-491-A ZB BOARD, COMPLETE

<CAPACITOR>

C1461	1-162-115-00	CERAMIC	330PF	10%	2KV
C1462	1-162-115-00	CERAMIC	330PF	10%	2KV

<CONNECTOR>

CN1471*1-580-689-11	PIN, CONNECTOR (PC BOARD) 4P
CN1472*1-564-507-11	PLUG, CONNECTOR 4P
CN1473*1-564-506-11	PLUG, CONNECTOR 3P

<RESISTOR>

R1461	1-249-414-11	CARBON	560	5%	1/4W	
R1462	1-249-414-11	CARBON	560	5%	1/4W	
R1463	1-202-822-00	SOLID	2.2K	20%	1/2W	
R1464	1-202-822-00	SOLID	2.2K	20%	1/2W	
R1465	1-216-475-11	METAL OXIDE	120	5%	3W	F
R1466	1-216-475-11	METAL OXIDE	120	5%	3W	F

MISCELLANEOUS

Δ 1-223-925-11	RESISTOR ASSY (HIGH-VOLTAGE)
Δ 1-452-790-11	NECK ASSY (KP-41T15)
Δ 1-452-790-21	NECK ASSY (KP-41T15)
1-504-785-11	SPEAKER (10CM)
1-556-945-21	CABLE, P-P
Δ 1-559-865-41	LEAD ASSY, HIGH-VOLTAGE
1-561-306-00	JACK, PIN (F)
Δ 1-769-837-11	CORD, POWER (WITH NOISE FILTER) 7.0A/125V
Δ 1-900-211-34	LEAD ASSY, HV
Δ 8-451-463-11	DY Y829PA2N (R), (G)
Δ 8-451-463-21	DY Y829PA2N2 (B)
Δ 8-598-955-00	BLOCK ASSY, HIGH-VOLTAGE
V901 Δ 8-736-078-05	PICTURE TUBE 07MAB5(G)
V902 Δ 8-736-079-05	PICTURE TUBE 07MAB5(B) (KP-41T15/46S15)
Δ 8-736-081-05	PICTURE TUBE 07MAB6(B) (KP-53S15)
V903 Δ 8-736-080-05	PICTURE TUBE 07MAB5(R) (KP-41T15/46S15)
Δ 8-736-082-05	PICTURE TUBE 07MAB6(R) (KP-53S15)

ACCESSORIES AND PACKING MATERIALS

3-798-907-21	MANUAL, INSTRUCTION	
*4-041-426-01	BAG, PROTECTION	(KP-53S15)
*4-042-463-01	SHEET, PROTECTION	(KP-53S15)
*4-047-776-01	TRAY	(KP-53S15)
*4-047-777-01	INDIVIDUAL CARTON	(KP-53S15)
*4-047-778-01	CUSHION (UPPER) (ASSY)	(KP-53S15)
*4-047-779-01	CUSHION (LOWER) (ASSY)	(KP-53S15)
*4-048-579-01	CUSHION (UPPER) (ASSY)	(KP-41T15)
*4-048-580-01	CUSHION (LOWER) (ASSY)	(KP-41T15)
*4-048-581-01	TRAY	(KP-41T15)
*4-048-582-01	INDIVIDUAL CARTON	(KP-41T15)
*4-049-155-01	BAG, PROTECTION	(KP-41T15)

REMOTE COMMANDER

1-467-059-21	REMOTE COMMANDER (RM-Y118)
9-903-826-01	COVER, BATTERY (FOR RM-Y118)

2-4. G BOARD REMOVAL

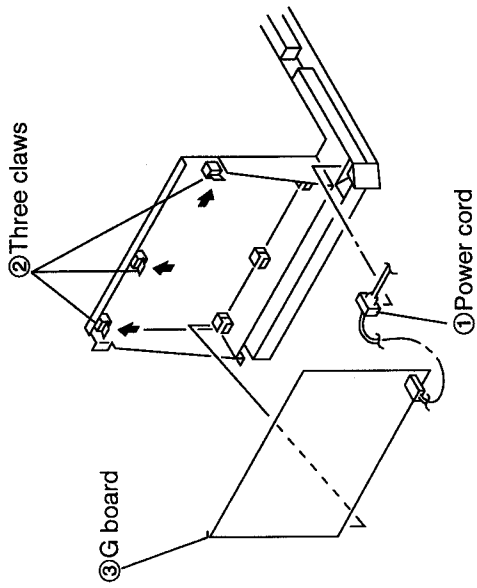

2-5. D BOARD REMOVAL

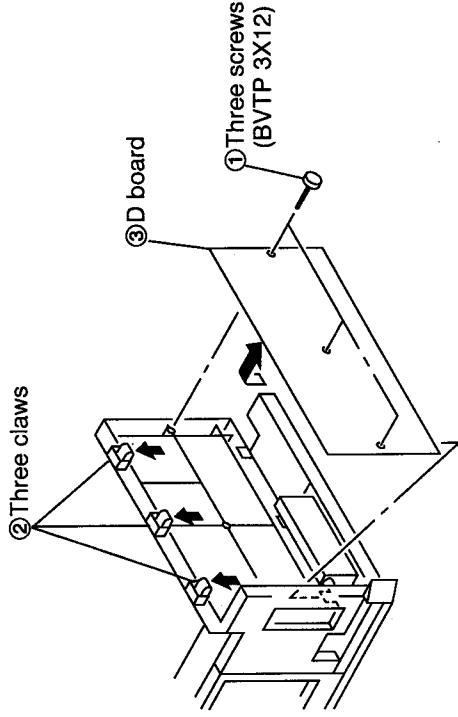

2-6. U BOARD REMOVAL

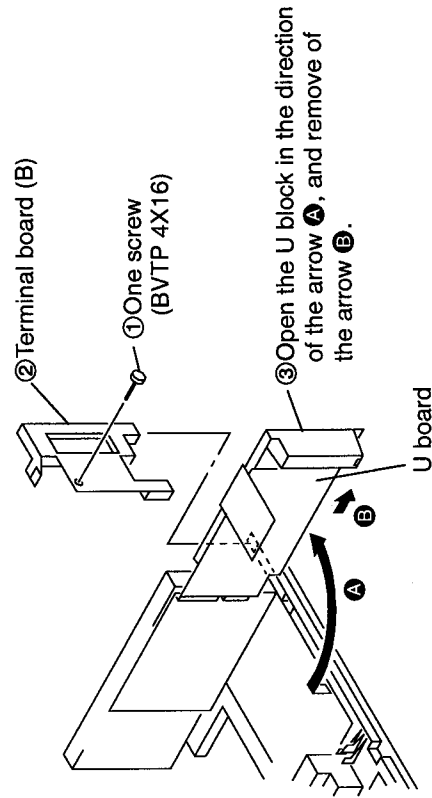

2-7. M BOARD REMOVAL

- ① Remove the D board. (Refer to 2-5.)
- ② Remove the U board. (Refer to 2-6.)

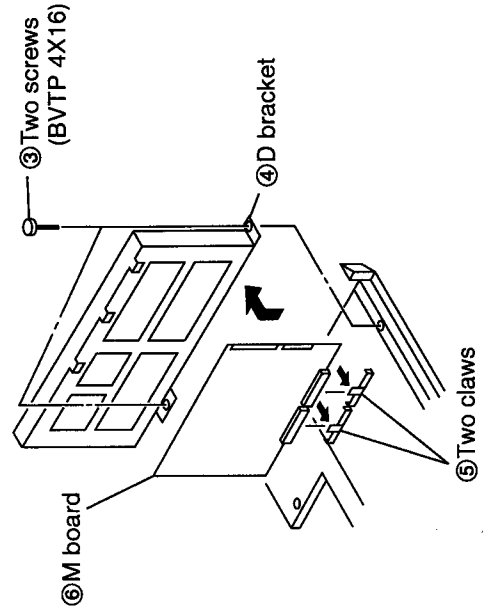

**2-8-1. HA BOARD REMOVAL
(KP-41T15)**

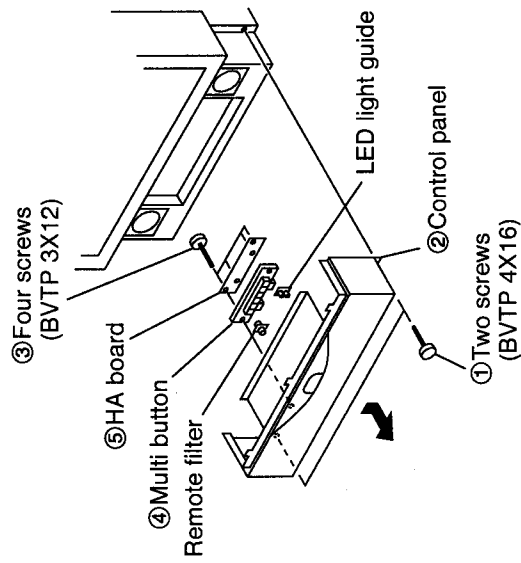

**2-8-2. HA BOARD REMOVAL
(KP-46S15/53S15)**

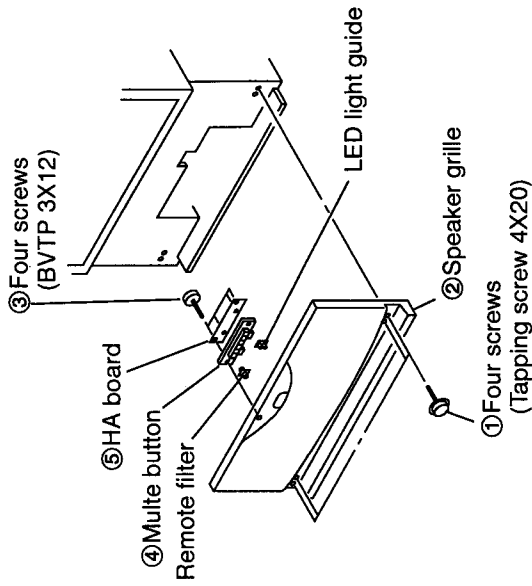

**2-9-1. BEZNET REMOVAL
(KV-41T15)**

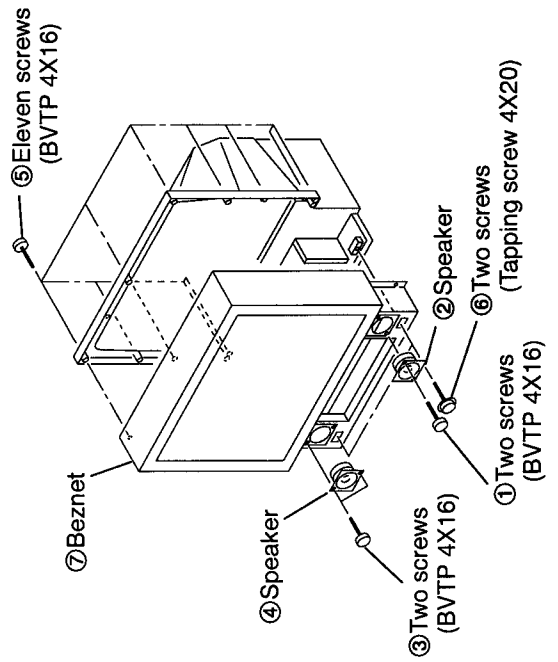

**2-9-2. BEZNET REMOVAL
(KV-46S15/53S15)**

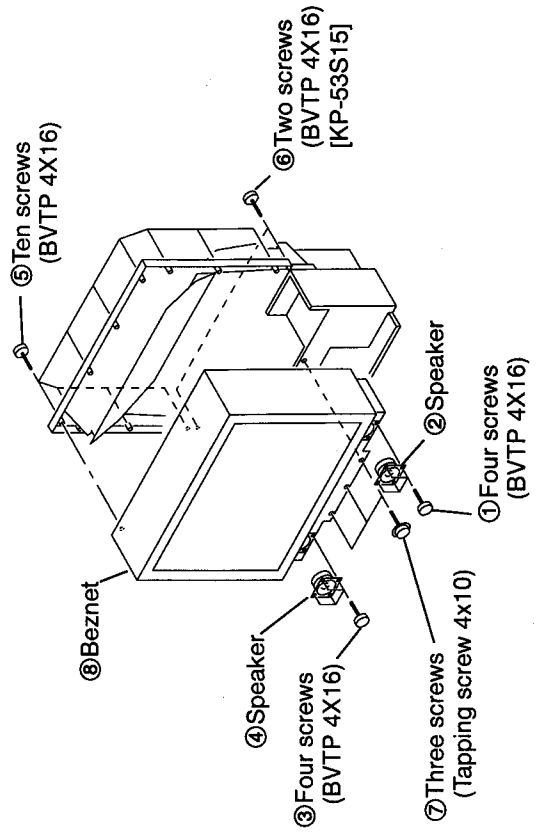

**2-10-1. MIRROR COVER REMOVAL
(KP-41T15)**

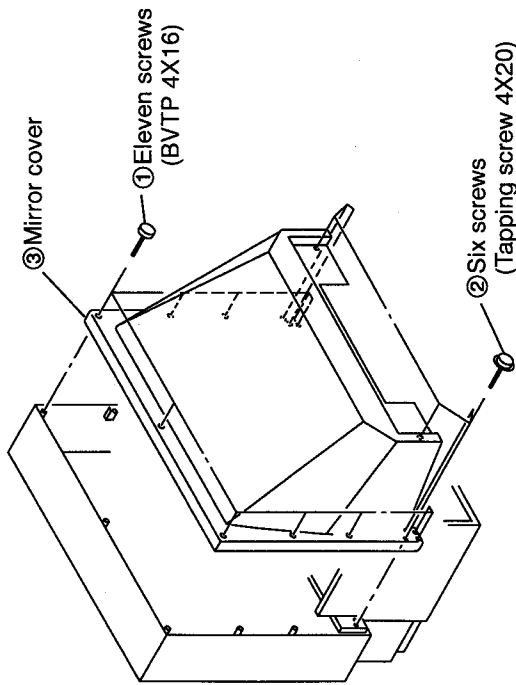

**2-10-2. MIRROR COVER REMOVAL
(KP-46S15/53S15)**

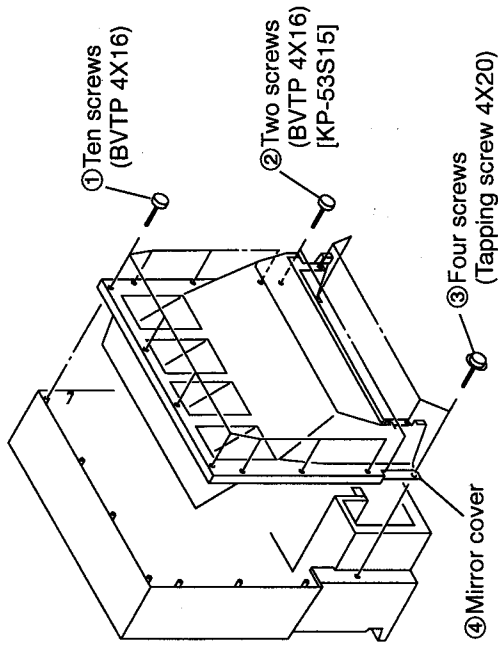

2-11. HIGH-VOLTAGE CABLE INSTALLATION AND REMOVAL

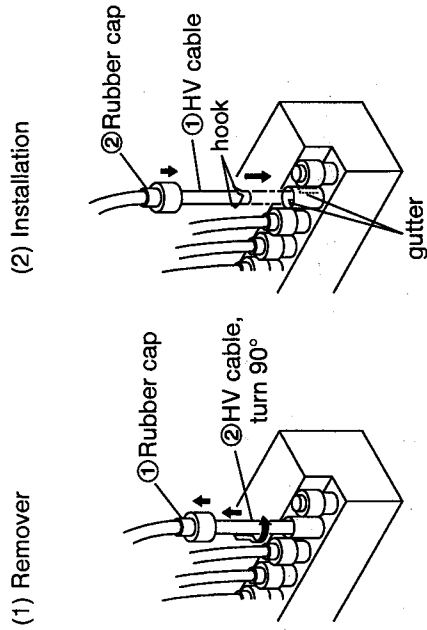

2-12. PICTURE TUBE REMOVAL

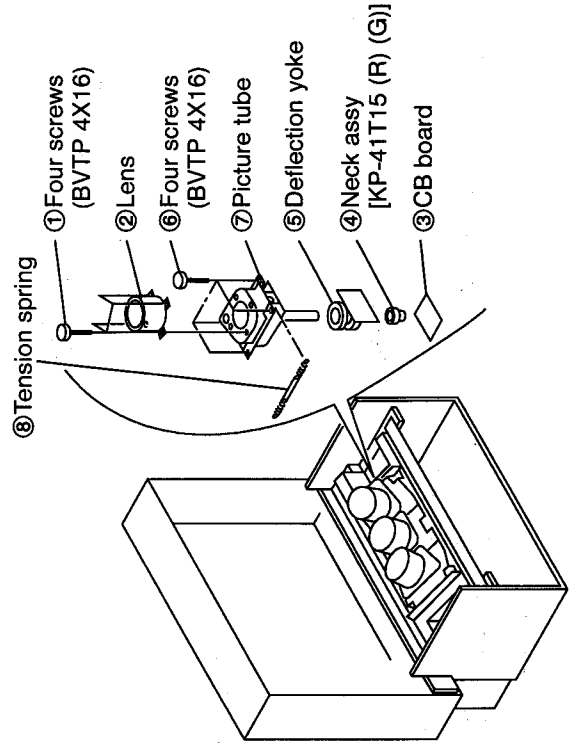

SECTION 3 SAFETY RELATED ADJUSTMENTS

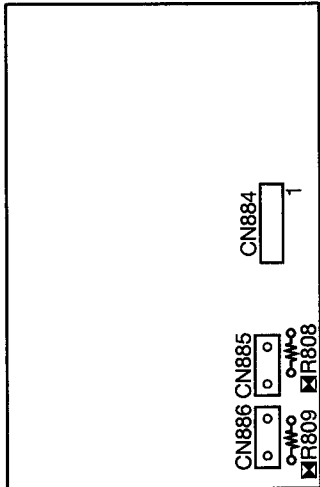
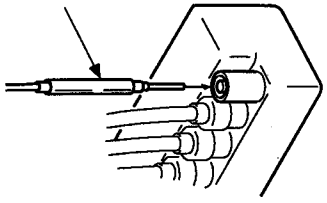
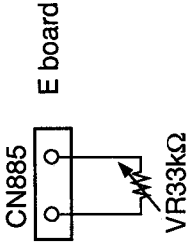
ADJUSTMENT ITEM AND PROCEDURE	EQUIPMENT AND SIGNAL	MEASUREMENT POSITION	ADJUSTMENT LOCATION	ILLUSTRATION AND SHAPE AND NUMBER
<p>HV HOLD DOWN CIRCUIT OPERATIONS CHECK AND ADJUSTMENT (*R RESISTOR)</p> <p>When replacing the parts marked * on the right, check the HV hold down and adjust.</p> <ol style="list-style-type: none"> 1. Remove the cap for the unconnected pin in the *high-voltage block and connect a *Static Voltmeter. 2. Input 130 VAC power. 3. Receive the *Dot signal and set the *PICTURE and BRIGHTNESS settings to their minimums. 4. Connect a *33 kΩ variable resistor across the E board *CN885 connector (with the variable resistor set to its maximum). 	<p>* Static Voltmeter</p> <p>* Dot pattern</p>	<p>* marked parts C818, D804, D806, D809, D909, D912, Q915, R809, R855, R856, R857, R858, R954, R955, R983, R984, R988, R991, R995, R996, R998, T803, FBT E board HV Block * HV Block</p>	<p>* R809, R988</p> <p>* PICTURE minimum BRIGHTNESS minimum</p>	<p>E BOARD - COMPONENT SIDE -</p>  <p>Remove the cap off from the unused terminal and connect a static voltmeter there.</p>  

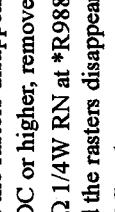
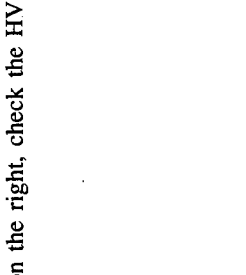
ADJUSTMENT ITEM AND PROCEDURE	EQUIPMENT AND SIGNAL	MEASUREMENT POSITION	ADJUSTMENT LOCATION	ILLUSTRATION AND SHAPE AND NUMBER
<p>5. Gradually lower the value of the variable resistor and check that the hold down circuit operates at a Static Voltmeter reading of *33.7 ± 0.8 kVDC and that the rasters disappear.</p> <p>6. If the hold down circuit operates and the rasters disappear at a Static Voltmeter reading of *34.0 VDC or higher, remove resistor *R809 and mount a *16.0 kΩ 1/4W RN at *R988. If the hold down circuit operates and the rasters disappear at a Static Voltmeter reading of *32.0 VDC or lower, remove resistor R809 and mount *6.2 kΩ 1/4W RN at *R988.</p> <p>7. Check Item 5 again.</p>			<p>* R988</p> <p>* R988</p>	<p>* 33.7 ± 0.8 kVDC</p> <p>* 34.0 VDC or higher</p> <p>* 16.0 kΩ 1/4W</p> <p>* 32.0 VDC or lower</p> <p>* 6.2 kΩ 1/4W</p> <p>* CN886 (E board)</p> 
<p>HV REGULATION CIRCUIT CHECK AND ADJUSTMENT (* RESISTOR)</p> <p>When replacing the parts marked * on the right, check the HV regulation and adjust.</p>		<p>* marked parts C918, C930, C934, C980, D902, D920, D925, Q909, R808, R851, R929, R936, R939, R942, R944, R945, R946, R947, R950, R960, R965, R967, R971, R975, R976, R982, R983, R985, R998.....</p> <p>E Board HV Block * HV Block</p>	<p>* R808, R983</p>	<p>E BOARD – COMPONENT SIDE –</p> 
<p>1. Remove the cap for the unconnected pin in the *high-voltage block and connect a *Static Voltmeter.</p> <p>2. Input 120 VAC power.</p> <p>3. Receive the *Dot signal and set the *PICTURE and BRIGHTNESS settings to their minimums.</p>	<p>* Static Voltmeter</p> <p>* Dot pattern</p>		<p>* PICTURE minimum BRIGHTNESS minimum</p>	

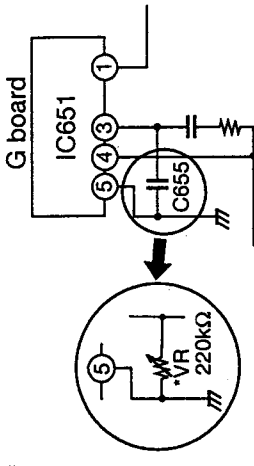
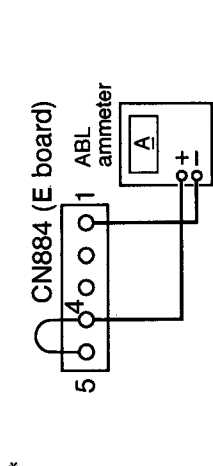
ADJUSTMENT ITEM AND PROCEDURE	EQUIPMENT AND SIGNAL	MEASUREMENT POSITION	ADJUSTMENT LOCATION	ILLUSTRATION AND SHAPE AND NUMBER
<p>OVERVOLTAGE PROTECTION (OVP) OPERATIONS CHECK</p> <ol style="list-style-type: none"> 1. Connect a *220 kΩ variable resistance rheostat to the G board C655 (between Pins ③ and ⑤ of IC651). 	* Dot pattern		<p>* PICTURE minimum BRIGHTNESS minimum</p>	 <p>* 120.0 \pm 1.0 VAC, 60 Hz</p>
<ol style="list-style-type: none"> 2. Input *120.0 \pm 1.0 VAC, 60 Hz power. 3. Receive the *Dot signal and set the *PICTURE and BRIGHTNESS settings to their minimums. 4. Gradually lower the value of the connected variable resistance and check that when the +B line *voltage is *143.5 \pm 5.5 VDC, the overvoltage circuit operates and the rasters disappear. 5. Remove the variable resistor and check the +B line voltage. 	* Digital Multimeter		* 143.5 \pm 5.5 VDC	 <p>* 120.0 \pm 1.0 VAC, 60 Hz</p>
<p>BEAM CURRENT (ΣIK) PROTECTION CIRCUIT CHECK</p> <ol style="list-style-type: none"> 1. Connect the *ABL ammeter between *Pins ① and ④ of the CN884 on the E board. Have Pins ② and ③ open. 2. Input *120.0 \pm 1.0 VAC, 60 Hz power. 3. Receive a *monoscope signal and set the *PICTURE and BRIGHTNESS settings to their minimums. 	* Ammeter		<p>* PICTURE minimum BRIGHTNESS minimum</p>	* 120.0 \pm 1.0 VAC, 60 Hz

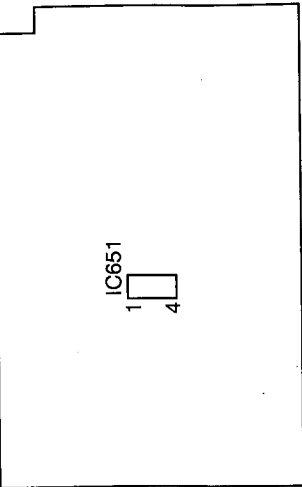
ADJUSTMENT ITEM AND PROCEDURE	EQUIPMENT AND SIGNAL	MEASUREMENT POSITION	ADJUSTMENT LOCATION	ILLUSTRATION AND SHAPE AND NUMBER
<p>4. Gradually raise the *PICTURE and BRIGHTNESS settings and check that below an *ABL current of 3.35 mA (including dark current), the beam current protection circuit operates and the rasters disappear.</p> <p>+B, +B MAX CHECK</p> <p>When replacing the G board IC651, check the following.</p> <ol style="list-style-type: none"> 1. Input *120.0 ± 1.0 V, 60 Hz power. 2. Receive the *Dot signal and set the *PICTURE and BRIGHTNESS settings to their minimums. 3. Check that the *+B line voltage is now *135.0 ± 2.0 VDC. 4. Set the power supply to *130.0 ^{+2.0}₋₀ VAC. 5. Check that the *+B line voltage is *137.0 VDC max. 6. If either 3 or 5 is not satisfied, replace IC651 again. 	<p>* Dot pattern</p>	<p>* CN681 pin ①</p> <p>* CN681 pin ①</p>	<p>* PICTURE BRIGHTNESS</p> <p>* PICTURE minimum BRIGHTNESS minimum</p>	<p>* Less than 3.35 mA</p> <p>E BOARD – COMPONENT SIDE –</p>  <p>* 120.0 ± 1.0 V, 60 Hz</p> <p>* 135.0 ± 2.0 VDC</p> <p>* 130.0 ^{+2.0}₋₀ VAC</p> <p>* Less than 137.0 VDC</p>

SECTION 4
DIAGRAMS

4-1. BLOCK DIAGRAMS (1)

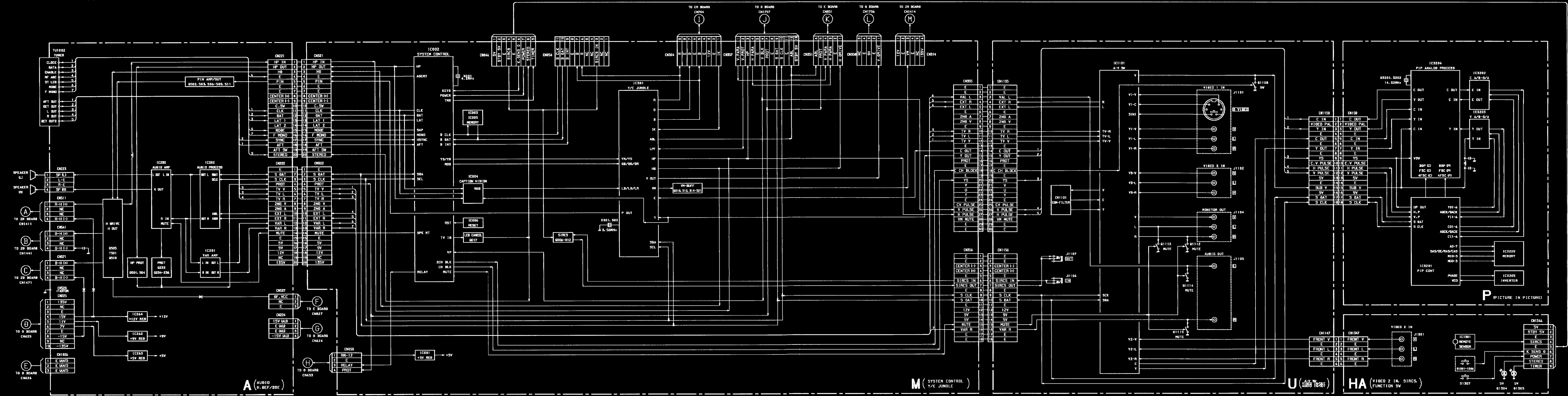

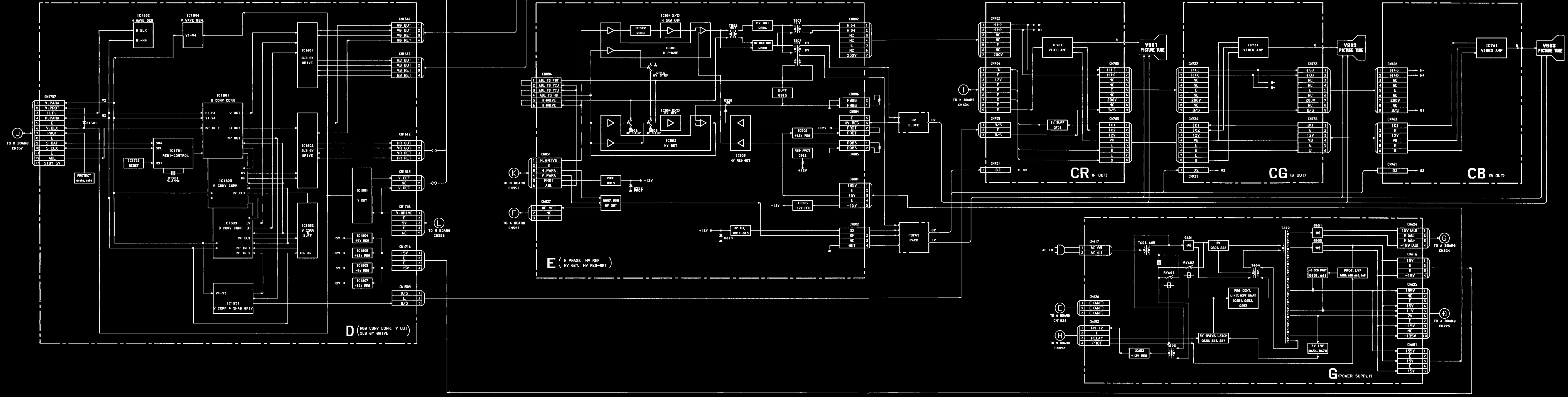
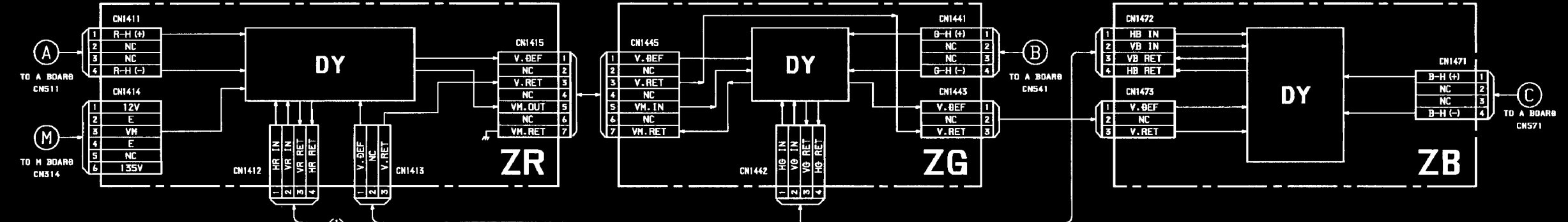

4-2. CIRCUIT BOARDS LOCATION

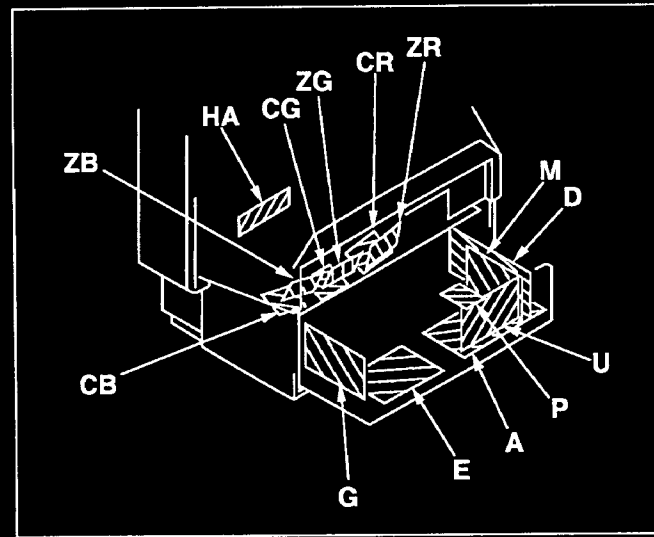

4-3. PRINTED WIRING BOARDS AND SCHEMATIC DIAGRAMS

Note:

- All capacitors are in μF unless otherwise noted. pF ; μF 50WV or less are not indicated except for electrolytics and tantalums.
- All resistors are in ohms.
- $k\Omega = 1000\Omega$, $M\Omega = 1000k\Omega$
- Indication of resistance, which does not have one for rating electrical power, is as follows.

Pitch: 5mm
Rating electrical power: 1/4W

- : nonflammable resistor.
- : fusible resistor.
- Δ : internal component.
- : panel designation and adjustment for repair.
- All variable and adjustable resistors have characteristic curve B, unless otherwise noted.
- : earth-chassis.
- The components identified by in this basic schematic diagram have been carefully factory-selected for each set in order to satisfy regulations regarding X-ray radiation. Should replacement be required, replace only with the value originally used.
- When replacing components identified by make the necessary adjustments indicated. If results do not meet the specified value, change the component identified by and repeat the adjustment until the specified value is achieved. (Refer to R808, R809, R983 and R988 adjustment on Page 20 - 24.)
- When replacing the part in below table, be sure to perform the related adjustment.

Part replaced ()	Adjustment ()
HV Block C815, D804, D806, D808, D909, D912, C818, R809, R855, R856, R857, R858, R954, R955, R983, R984, R988, R991, R995, R996, R998, T801 (FBT), T803E BOARD	HV HOLD-DOWN (R809, R988)
HV Block C909, D902, D920, D925, C918, C930, C934, C980, R808, R851, R929, R938, R939, R942, R944, R945, R946, R947, R950, R965, R967, R971, R975, R976, R982, R983, R985, R998E BOARD	HV Reagurater (R808, R983)

Reference information

RESISTOR	: RN	METAL FILM
	: RC	SOLID FILM
	: FPRD	NONFLAMMABLE CARBON
	: FUSE	NONFLAMMABLE FUSIBLE
	: RW	NONFLAMMABLE WIREWOUND
	: RS	NONFLAMMABLE METAL OXIDE
	: RB	NONFLAMMABLE CEMENT
	: R	ADJUSTMENT RESISTOR
COIL	: LF-8L	MICRO INDUCTOR
CAPACITOR	: TA	TANTALUM
	: PS	STYROL
	: PP	POLYPROPYLENE
	: PT	MYLAR
	: MPS	METALIZED POLYESTER
	: MPP	METALIZED POLYPROPYLENE
	: ALB	BIPOLAR
	: ALT	HIGH TEMPERATURE
	: ALR	HIGH RIPPLE

- As to the voltage value shown by the semiconductors on the Schematic Diagram, see the another list.
- Readings are taken with a color-bar signal input.
- Readings are taken with a 10M Ω digital multimeter.
- Voltages are dc with respect to ground unless otherwise noted.
- Voltage variations may be noted due to normal production tolerances.
- All voltages are in V.
- *: Measurement impossibility.
- Circled numbers are waveform references.
- : B+ bus.
- : B- bus.
- : signal path (B+)

Note: The symbol -display is on the component side.

The components identified by shading and mark Δ are critical for safety. Replace only with part number specified.

The symbol indicate fast operating fuse. Replace only with fuse of same rating as marked.

Note: Les composants identifiés par un tramé et une marque Δ sont critiques pour la sécurité. Ne les remplacer que par une pièce portant le numéro spécifié.

Le symbole indique une fusible à action rapide. Doit être remplacée par une fusible de même valeur, comme marqué.

A BOARD

IC	Q509	F - 4	
IC201	B - 9	Q510	F - 2
IC202	B - 7	Q511	C - 5
IC230	D - 8	Q1003	D - 12
IC262	A - 3	Q1004	G - 13
IC263	A - 2		
IC264	A - 5		
DIODE			
	D201	C - 8	
	D202	C - 8	
	D220	D - 6	
	D221	C - 6	
	D231	D - 9	
	D232	D - 10	
	D262	A - 12	
	D263	A - 11	
	D264	A - 12	
	D501	C - 4	
	D502	B - 4	
	D504	C - 5	
	D505	G - 5	
	D506	G - 3	
	D507	F - 1	
	D509	C - 2	
	D510	C - 3	
	D511	G - 5	
	D1001	B - 12	
TRANSISTOR			
	Q220	C - 7	
	Q221	C - 7	
	Q223	C - 7	
	Q230	D - 6	
	Q231	D - 6	
	Q232	D - 10	
	Q234	D - 9	
	Q235	E - 10	
	Q236	D - 9	
	Q501	C - 5	
	Q502	E - 6	
	Q503	E - 6	
	Q504	B - 5	
	Q505	E - 4	
	Q506	E - 5	
	Q507	E - 4	
	Q508	E - 5	

A AUDIO, H. DEF/BBE

- A BOARD -

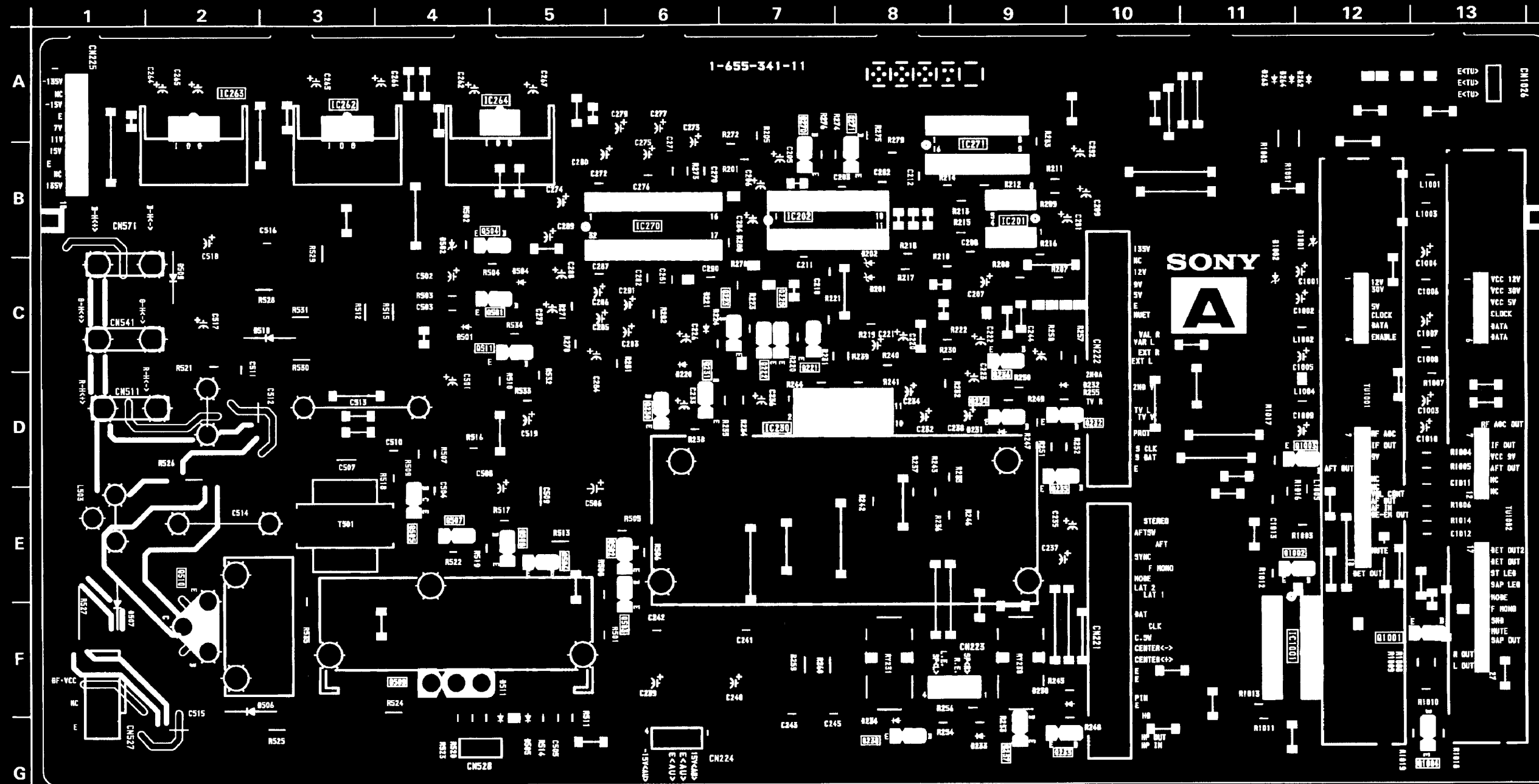

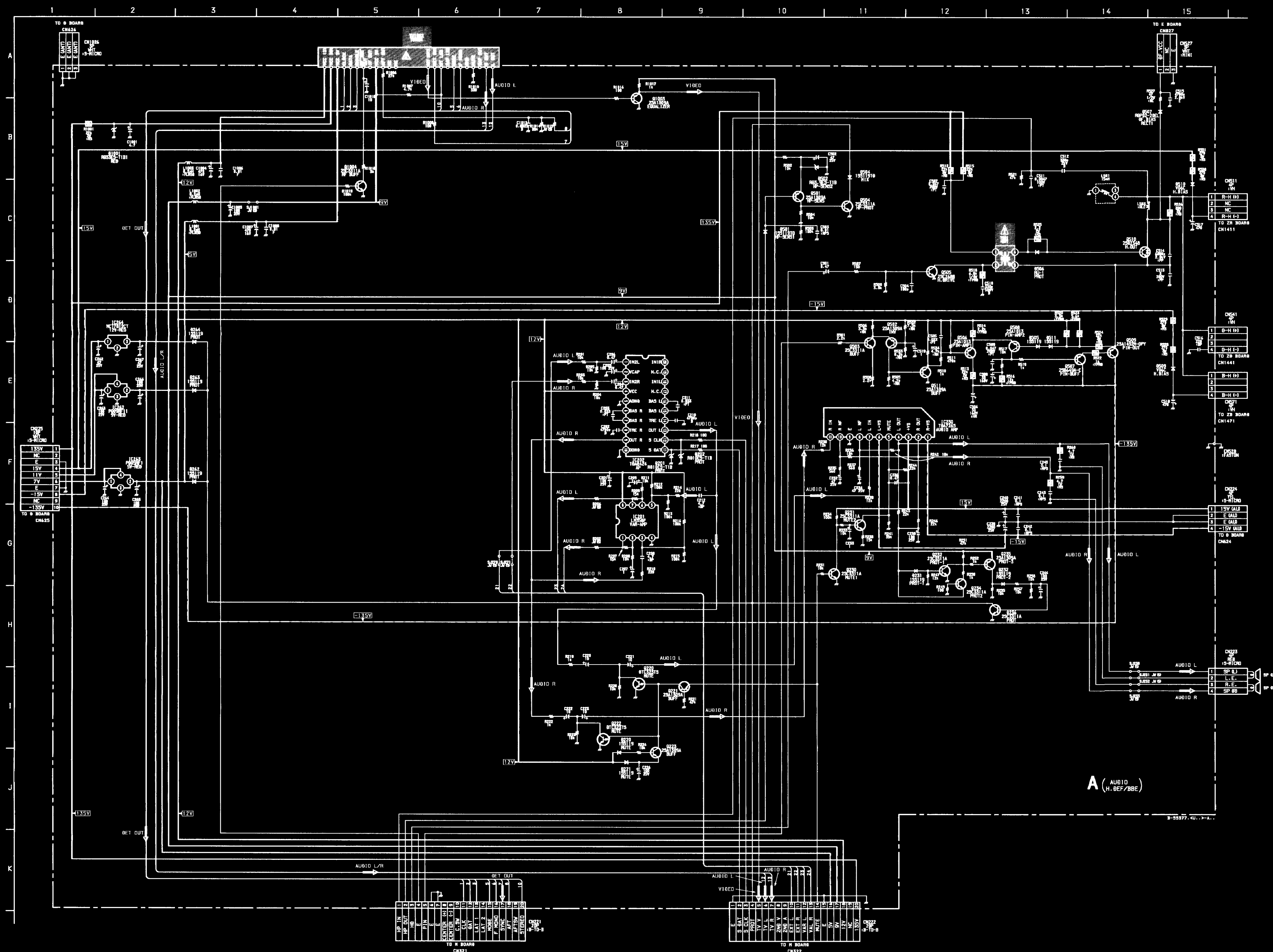

A BOARD TRANSISTOR VOLTAGE LIST

	E	C	B
Q220	GND	0	2.8
Q221	2.8	2.8	2.8
Q222	GND	0	2.8
Q223	11.9	2.8	11.1
Q230	GND	0	0.7
Q231	0	10.6	0
Q232	GND	9.0	0
Q233	0	9.0	0
Q235	9.0	0	9.0
Q236	GND	4.6	0
Q501	3.2	0	4.1
Q502	6.9	0.9	6.4
Q503	3.1	6.9	3.7
Q504	GND	4.9	0
Q506	GND	63.7	-0.7
Q506	2.1	-54.0	1.6
Q507	-124.3	-137.3	-121.6
Q508	2.1	-121.6	1.7
Q509	-122.9	-137.3	-123.2
Q510	-122.9	*	-123.5
Q511	1.6	GND	0.9
Q1003	5.6	GND	5.1
Q1004	GND	0	0

* : MEASUREMENT IMPOSSIBILITY

A BOARD IC VOLTAGE LIST

ALL VOLTAGES ARE IN V

IC201	1 6.1	3 6.1	5 6.1	7 6.1
	2 6.1	4 GND	6 6.1	8 12.0
IC202	1 6.0	5 GND	9 6.1	13 6.1
	2 12.0	6 6.1	10 GND	14 6.1
	3 6.0	7 6.1	11 4.6	15 6.1
	4 12.0	8 6.1	12 4.6	16 6.1
				20 NC
IC230	1 -16.3	4 0	7 0	10 0
	2 0	5 10.5	8 0	11 0
	3 15.0	6 -16.3	9 GND	
IC262	1 11.0	2 9.0	3 GND	4 11.0
IC263	1 7.0	2 5.0	3 GND	4 7.0
IC264	1 15.0	2 GND	3 12.0	

A BOARD WAVEFORMS

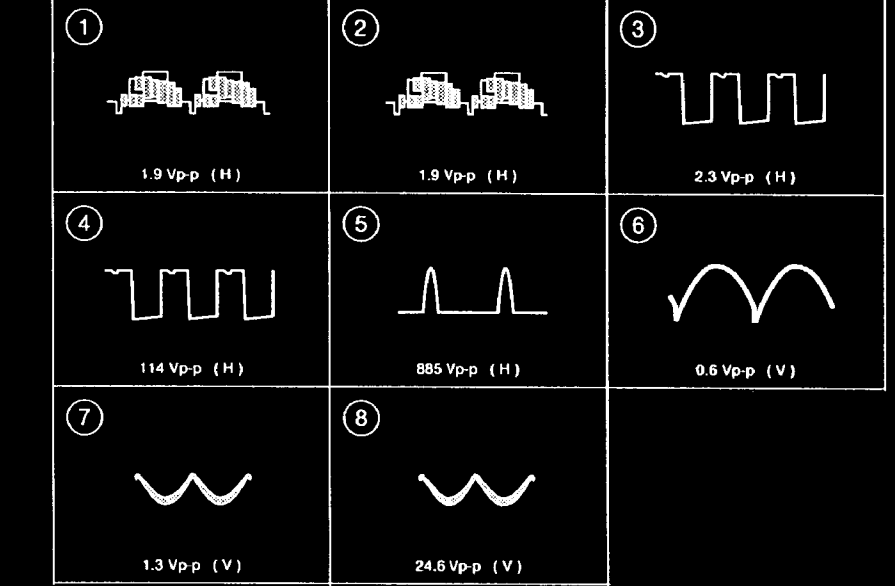

A BOARD IC201 LM358P

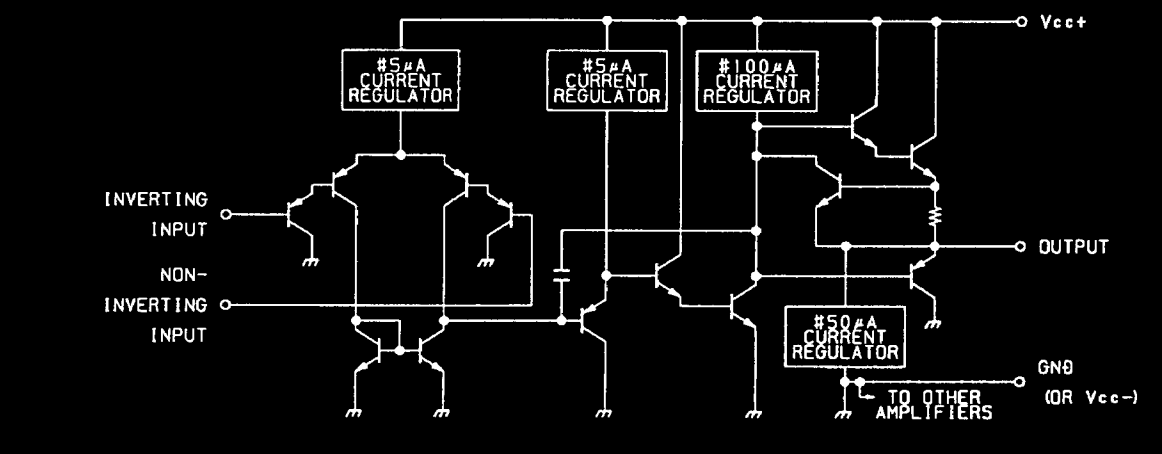

A BOARD IC202 TDA8424

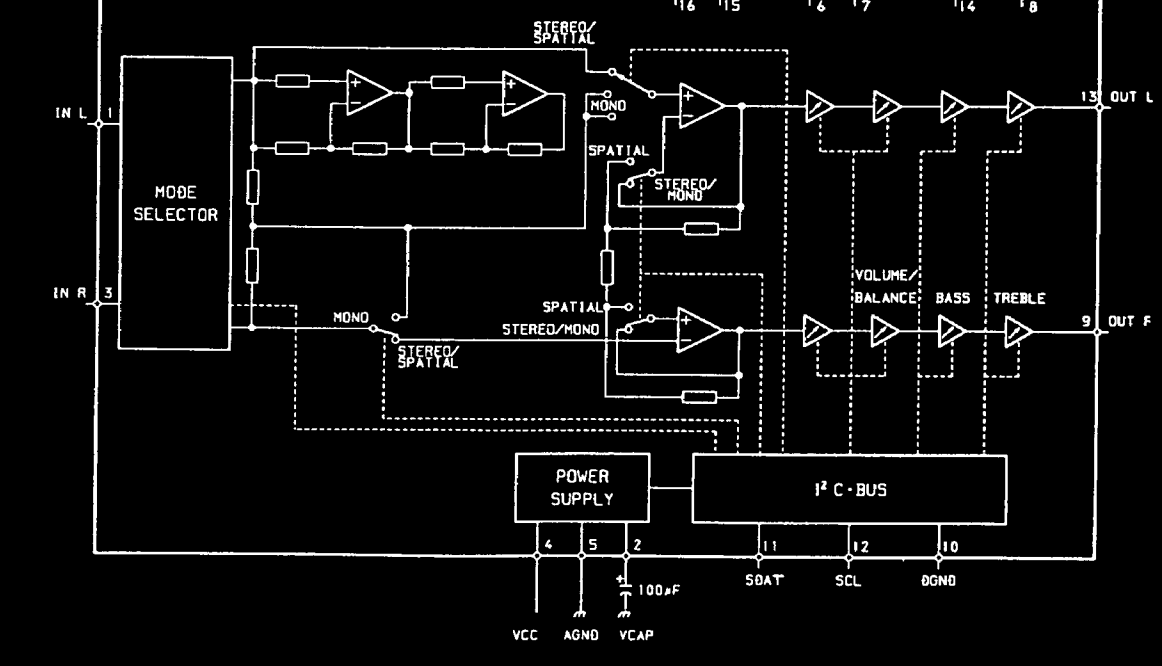

D BOARD IC VOLTAGE LIST ALL VOLTAGES ARE IN V

IC1601	1 1.5	3 -13.8	5 0.3	7 1.5
IC1601	1 -13.3	6 0.4	11 14.2	16 -15.0
IC1601	2 -13.3	7 0.4	12 -14.3	17 -15.0
IC1601	3 -13.3	8 GND	13 -14.3	18 15.0
IC1601	4 0	9 0	14 14.2	19 -15.0
IC1601	5 0	10 0	15 15.0	20 0
IC1602	1 -13.3	6 -0.1	11 14.2	16 -15.0
IC1602	2 -13.3	7 -0.1	12 -14.3	17 -15.0
IC1602	3 -13.3	8 GND	13 -14.3	18 15.0
IC1602	4 0.2	9 -0.5	14 14.2	19 -15.0
IC1602	5 0.2	10 -0.5	15 15.0	20 -0.2
IC1701	1 NC	15 NC	29 NC	43 0
IC1701	2 NC	16 NC	30 0.7	44 0
IC1701	3 NC	17 NC	31 0.3	45 NC
IC1701	4 NC	18 NC	32 GND	46 GND
IC1701	5 NC	19 NC	33 NC	47 GND
IC1701	6 NC	20 NC	34 2.7	48 GND
IC1701	7 NC	21 5.1	35 2.5	49 NC
IC1701	8 NC	22 NC	36 5.2	50 NC
IC1701	9 NC	23 NC	37 NC	51 NC
IC1701	10 NC	24 3.2	38 NC	52 NC
IC1701	11 NC	25 NC	39 0	53 NC
IC1701	12 NC	26 NC	40 0	54 4.7
IC1701	13 NC	27 NC	41 0	55 NC
IC1701	14 NC	28 NC	42 0	56 4.6
IC1702	1 5.2	2 5.0	3 GND	
IC1801	1 0	10 3.4	19 0	28 0
IC1801	2 -0.9	11 5.1	20 -0.5	29 0
IC1801	3 0	12 0.7	21 5.0	30 0
IC1801	4 -1.1	13 3.2	22 0	31 3.2
IC1801	5 0	14 -2.1	23 1.5	32 0.7
IC1801	6 -0.4	15 0	24 0	33 3.2
IC1801	7 GND	16 -0.9	25 0	34 3.4
IC1801	8 5.2	17 0	26 0	35 0
IC1801	9 -5.0	18 -0.9	27 0	36 0
IC1802	1 0.8	5 -0.9	9 -5.0	13 0.4
IC1802	2 1.2	6 0	10 0.3	14 1.3
IC1802	3 5.0	7 -1.1	11 0.6	15 GND
IC1802	4 0	8 0	12 -0.9	16 -1.7

IC1803	1 -5.0	2 -15.0	3 GND
IC1804	1 5.0	2 GND	3 15.0
IC1805	1 0	10 3.4	19 0
IC1805	2 -0.9	11 5.2	20 -0.5
IC1805	3 0.2	12 0.7	21 5.0
IC1805	4 -1.1	13 3.2	22 0
IC1805	5 0	14 -2.1	23 0
IC1805	6 -0.4	15 0	24 0
IC1805	7 5.1	16 -0.9	25 0.4
IC1805	8 5.2	17 0	26 0
IC1805	9 -5.0	18 -0.9	27 0
IC1806	1 0.2	5 -0.9	9 -5.0
IC1806	2 1.3	6 0	10 0.3
IC1806	3 5.0	7 -1.0	11 0.6
IC1806	4 0	8 0	12 -0.9
IC1807	1 -12.0	2 -15.0	3 GND
IC1808	1 12.0	2 GND	3 15.0
IC1809	1 0	10 3.4	19 0
IC1809	2 -0.9	11 5.1	20 -0.5
IC1809	3 0.2	12 0.7	21 5.0
IC1809	4 -1.1	13 3.2	22 0
IC1809	5 0	14 -2.2	23 -0.7
IC1809	6 -0.4	15 0	24 0
IC1809	7 -5.0	16 -0.9	25 0
IC1809	8 5.1	17 0	26 0
IC1809	9 -5.0	18 -0.9	27 0
IC1931	1 0	4 12.0	7 0.4
IC1931	2 0	5 0	8 NC
IC1931	3 0	6 0	9 NC
IC1932	1 0.7	4 12.0	7 -0.7
IC1932	2 0	5 GND	8 0
IC1932	3 GND	6 0	9 0

D BOARD IC1802 PA0053B

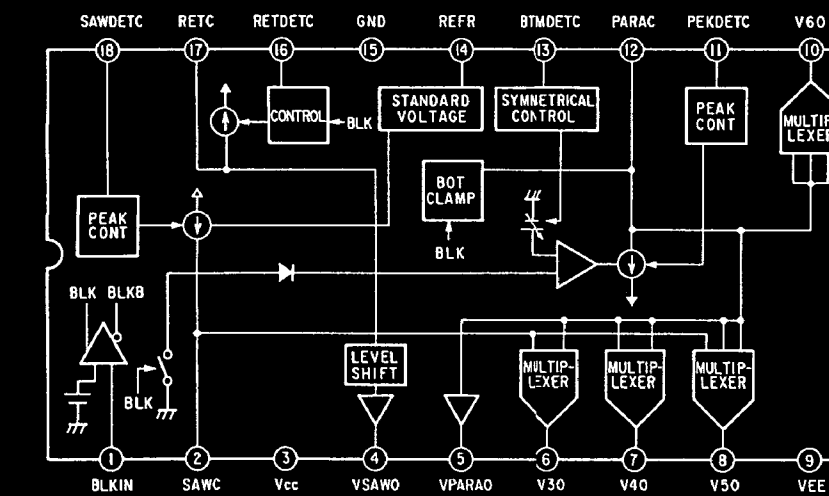

D BOARD TRANSISTOR VOLTAGE LIST

Q1501	E	C	B
Q1551	0.2	2.1	-0.5
Q1552	4.0	2.1	3.4
Q1553	1.5	12.0	2.1
Q1701	GND	3.5	0.3
Q1801	2.6	5.0	3.2
Q1802	-2.5	-5.0	-3.1
Q1803	GND	4.8	0
Q1804	-0.3	0	-0.9
Q1805	GND	4.8	0

D BOARD WAVEFORMS

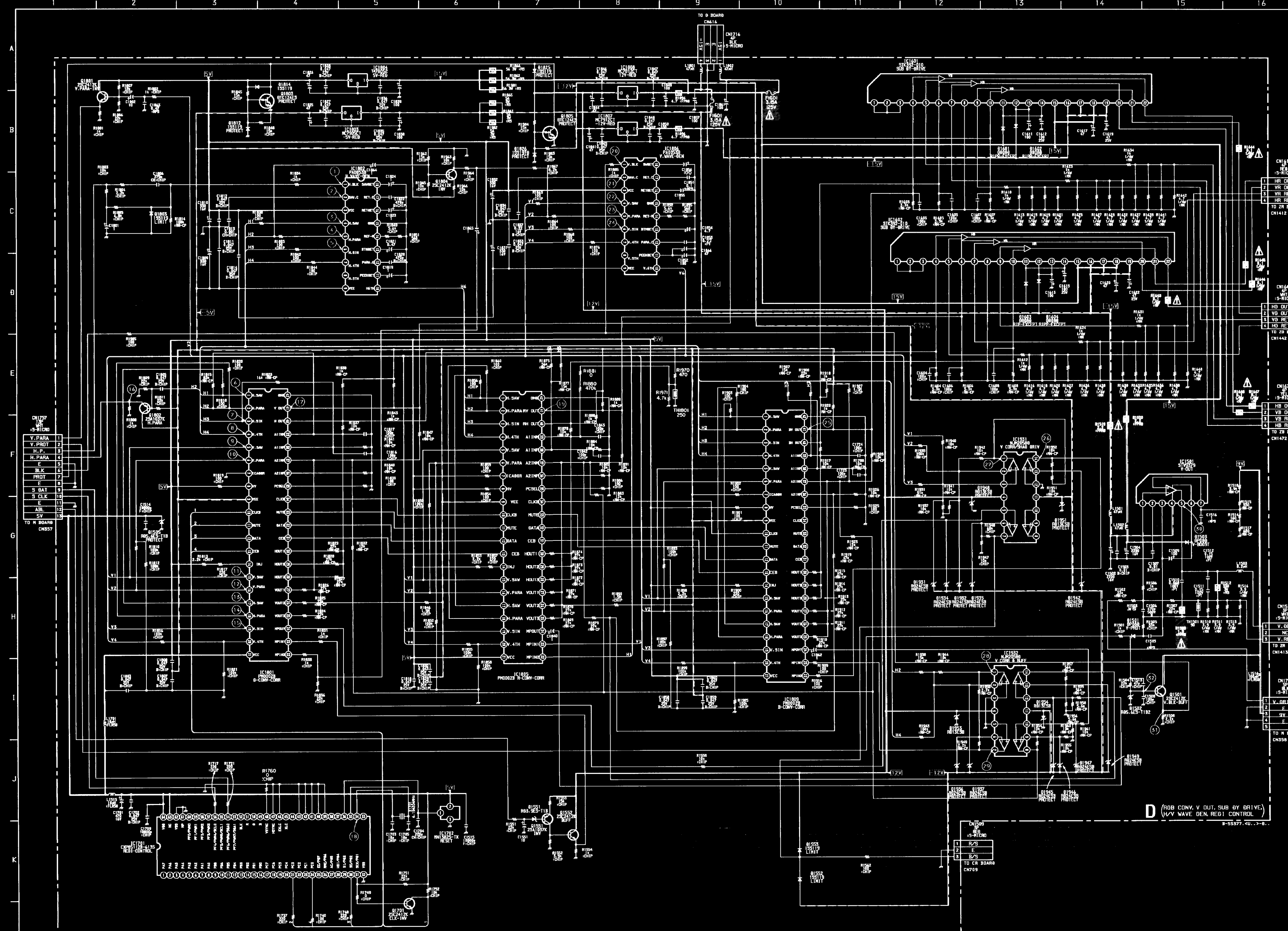
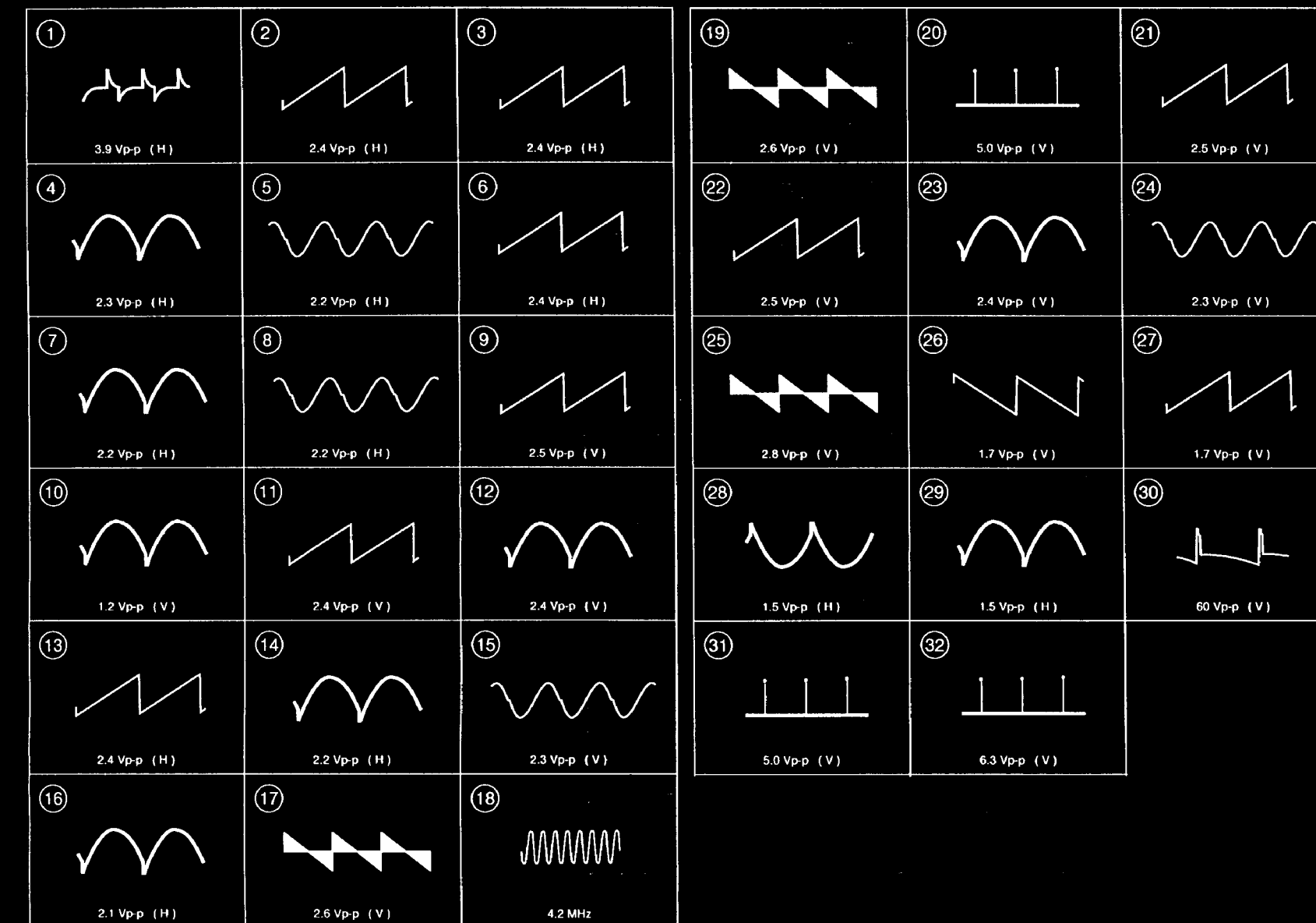

D [RGB CONV, V OUT, SUB DY DRIVE,
H/V WAVE GEN, REGI CONTROL]

- D BOARD -

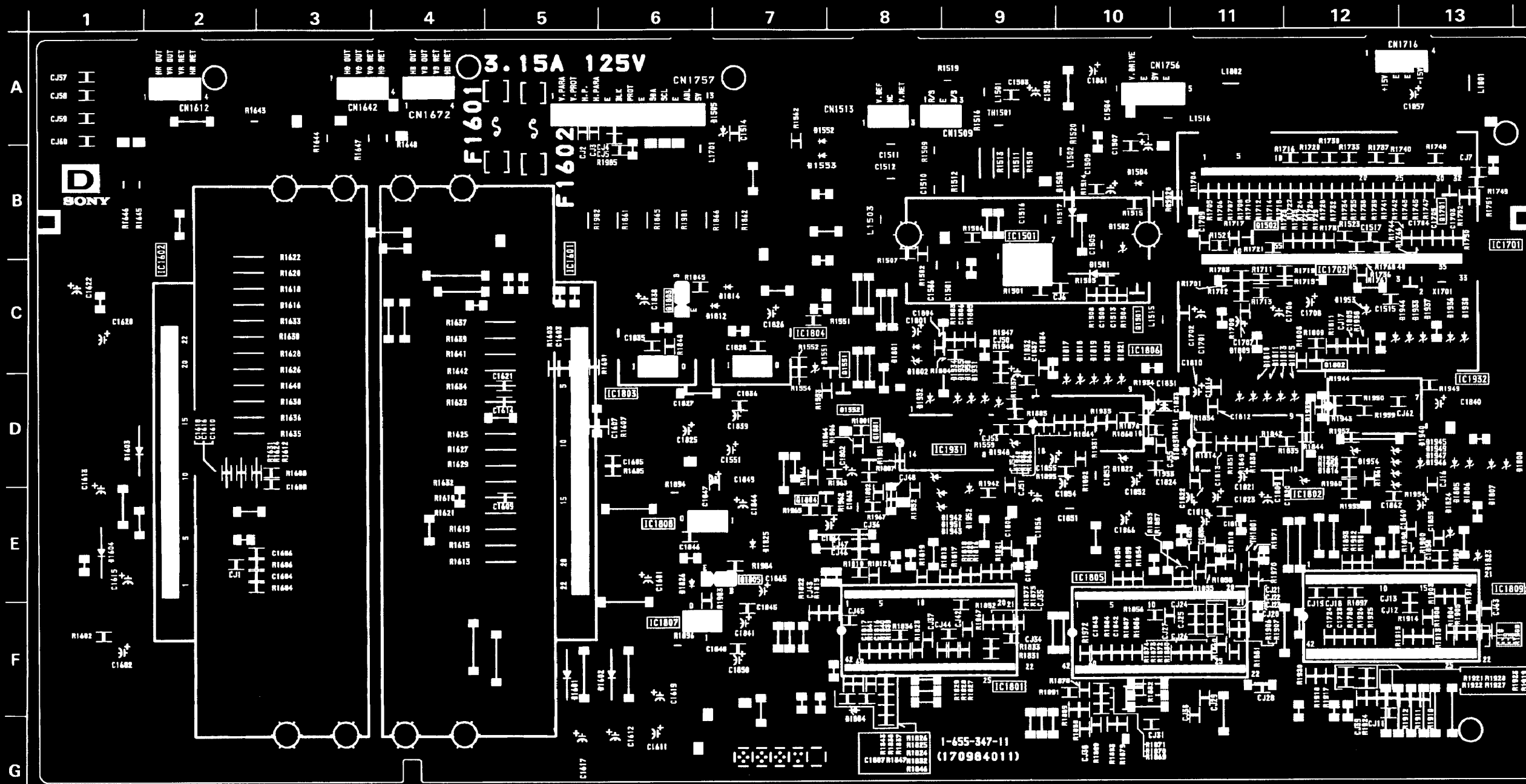

D BOARD

IC	IC1807 F-7	Q1802 C-12	D1601 F-5	D1935 D-9
IC1501 C-9	IC1808 E-7	Q1803 C-6	D1602 F-6	D1936 C-13
IC1601 C-5	IC1809 F-12	Q1804 E-8	D1603 D-2	D1937 C-13
IC1602 D-2	IC1931 D-9	Q1805 E-7	D1604 E-1	D1942 E-9
IC1701 B-12	IC1932 D-13	DIODE	D1803 D-11	D1945 D-13
IC1702 C-12	TRANSISTOR		D1812 C-7	D1946 E-13
IC1801 F-9		Q1501 C-10	D1814 C-7	D1947 E-13
IC1802 D-12	Q1502 B-11	D1825 E-7	D1948 D-9	
IC1803 D-6	Q1551 D-8	D1826 E-6	D1949 D-13	
IC1804 D-7	Q1552 D-8	D1827 E-6	D1951 E-9	
IC1805 F-10	Q1701 B-13	D1931 D-9	D1953 C-12	
IC1806 D-10	Q1801 D-8	D1932 D-9	D1954 D-12	
		D1934 D-9		

1-655-347-11
(170984011)

U [COM FILTER, AV, SW,
VIDEO OUT, AUDIO OUT]

- **U BOARD** -

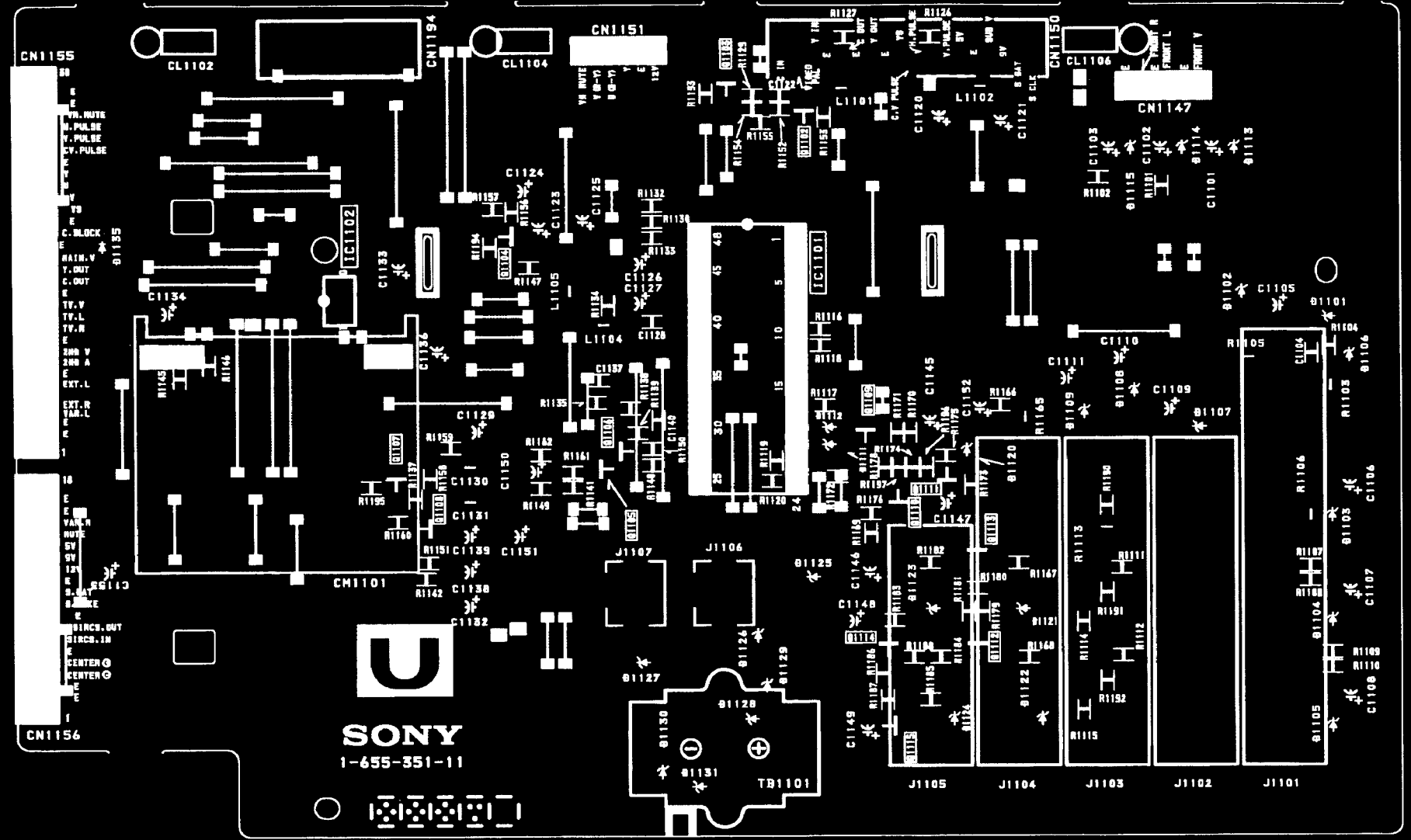

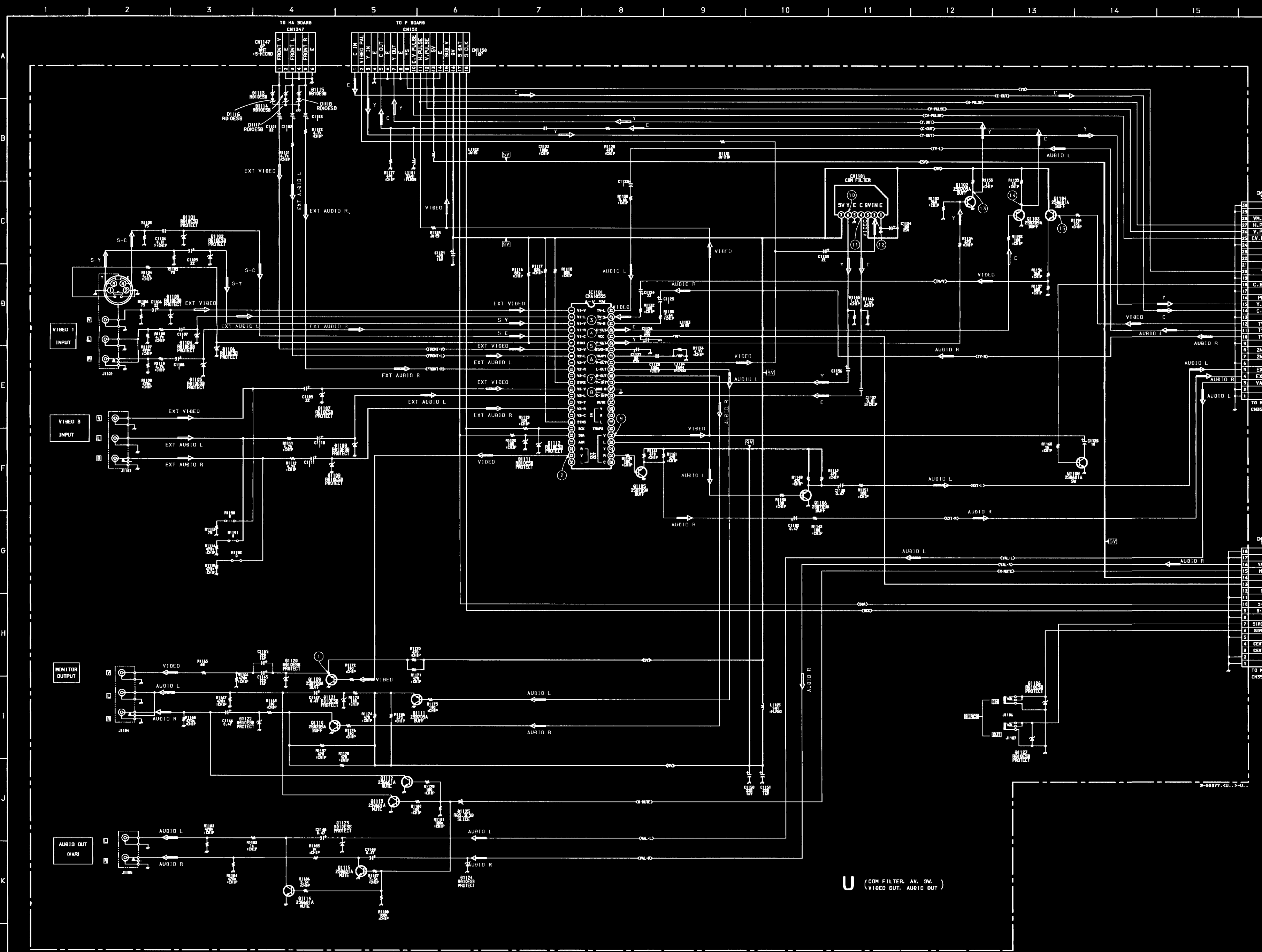

U (COM FILTER, AV, SV, VIDEO OUT, AUDIO OUT)

U BOARD IC VOLTAGE LIST

ALL VOLTAGES ARE IN V

IC1101	1 GND	3 9.0	5 GND	7 9.0	
1	4.7	11 NC	21 NC	31 4.7	41 4.7
2	4.7	12 5.0	22 NC	32 4.7	42 4.7
3	4.7	13 4.7	23 4.6	33 4.7	43 4.4
4	4.7	14 4.7	24 NC	34 NC	44 9.0
5	4.7	15 NC	25 NC	35 4.7	45 4.7
6	5.0	16 4.7	26 4.8	36 GND	46 4.7
7	3.6	17 NC	27 NC	37 4.7	47 4.7
8	4.7	18 5.0	28 4.8	38 4.8	48 4.7
9	NC	19 4.6	29 4.6	39 4.8	
10	4.7	20 4.6	30 4.7	40 4.6	

U BOARD TRANSISTOR VOLTAGE LIST

	E	C	B
Q1102	3.1	GND	2.5
Q1103	5.3	GND	4.7
Q1104	5.1	9.0	5.8
Q1105	5.4	GND	4.8
Q1106	5.4	GND	4.8
Q1107	0	9.0	-0.3
Q1108	GND	0.9	-1.1
Q1109	5.3	GND	4.6
Q1110	5.4	GND	4.8
Q1111	5.4	GND	4.8
Q1112	GND	0	0
Q1113	GND	0	0
Q1114	GND	0	0
Q1115	GND	0	0

U BOARD WAVEFORMS

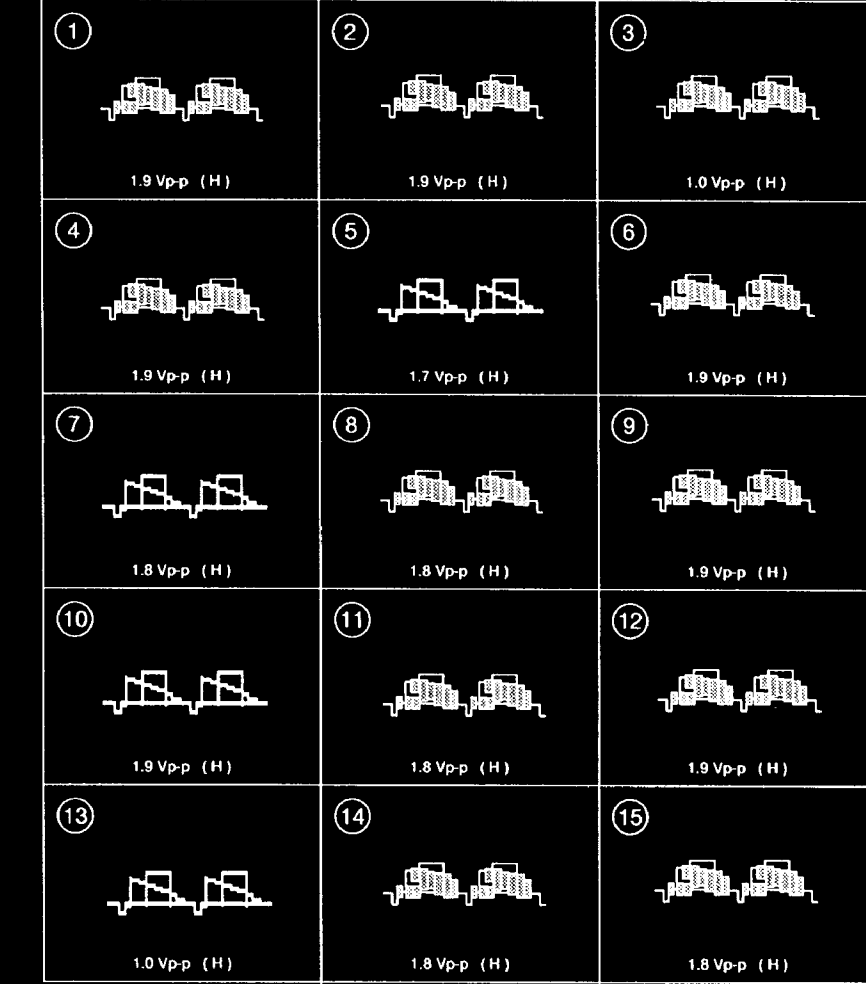

U BOARD IC1101 CXA1855S

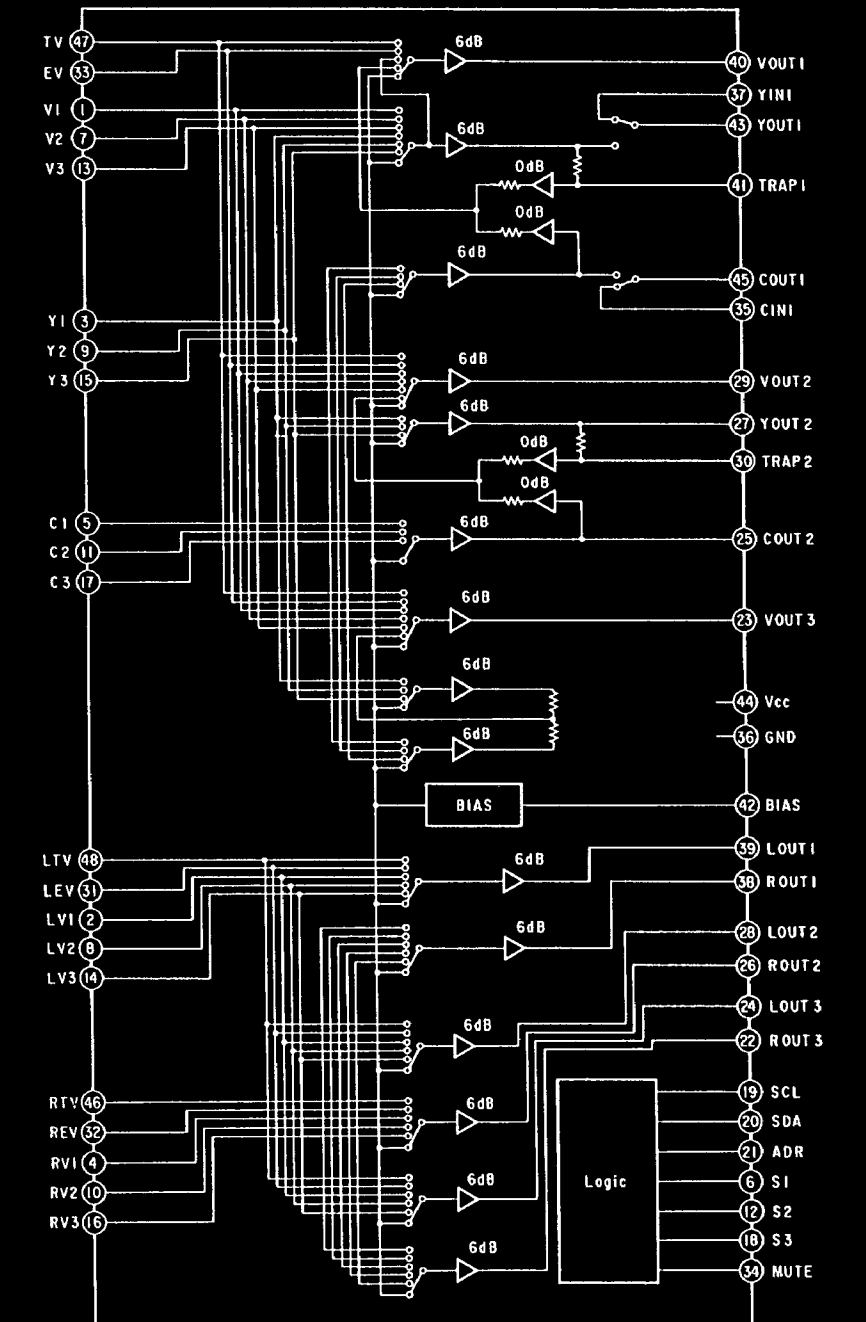

M BOARD IC VOLTAGE LIST

ALL VOLTAGES ARE IN V

M BOARD TRANSISTOR VOLTAGE LIST

IC001	1 12.0	2 GND	3 5.0		
IC002	1 0.8	15 0	29 0	43 5.1	57 3.2
	2 0.2	16 0	30 5.0	44 5.1	58 GND
	3 4.8	17 0	31 5.0	45 3.0	59 GND
	4 4.5	18 5.1	32 GND	46 3.0	60 GND
	5 0	19 0	33 0	47 0	61 GND
	6 5.2	20 0	34 2.6	48 0	62 GND
	7 5.1	21 0	35 2.3	49 0	63 5.0
	8 0	22 0	36 5.1	50 NC	64 5.0
	9 0	23 0	37 0	51 0	
	10 5.1	24 0	38 5.1	52 0	
	11 0	25 0	39 2.3	53 4.5	
	12 0	26 5.1	40 GND	54 4.6	
	13 0	27 5.1	41 5.1	55 4.6	
	14 0	28 0	42 5.1	56 4.6	
IC003	1 GND	3 GND	5 4.6	7 GND	
	2 GND	4 GND	6 4.6	8 5.0	
IC004	1 0	5 0	9 GND	13 2.2	17 5.0
	2 5.0	6 0	10 GND	14 5.0	18 5.0
	3 0	7 0	11 1.8	15 5.0	
	4 NC	8 0.9	12 1.7	16 GND	
IC005	1 GND	3 GND	5 4.6	7 GND	
	2 5.1	4 GND	6 4.6	8 5.0	
IC006	1 5.1	2 5.2	3 GND		
IC301	1 4.4	11 0	21 0	31 3.7	41 3.4
	2 7.4	12 5.0	22 1.7	32 3.0	42 3.6
	3 5.4	13 5.7	23 1.7	33 3.7	43 3.0
	4 GND	14 5.7	24 1.6	34 GND	44 GND
	6 4.1	15 GND	25 5.4	35 4.7	45 3.6
	6 5.5	16 6.0	26 NC	36 5.1	46 3.0
	7 2.5	17 6.0	27 *	37 4.0	47 4.6
	8 9.0	18 6.0	28 8.9	38 GND	48 4.6
	9 0	19 6.0	29 NC	39 2.5	
	10 0	20 0	30 3.0	40 4.3	

Q001	5.0	0.8	5.3
Q002	0	6.0	0.7
Q003	0	5.0	0
Q004	0.7	GND	0
Q005	3.4	5.0	4.2
Q006	0	6.2	0.7
Q007	5.2	0	5.1
Q008	0	0	5.1
Q009	GND	6.2	0
Q010	0	5.1	0
Q011	5.2	6.1	4.8
Q012	GND	5.0	0
Q017	9.0	5.3	5.7
Q018	5.0	5.0	4.4
Q019	GND	0.2	0.7
Q301	2.7	GND	4.1
Q302	2.6	GND	1.9
Q303	2.6	GND	1.9
Q304	2.6	GND	1.9
Q305	GND	8.9	0
Q307	GND	0	0.7
Q308	3.1	GND	2.3
Q309	4.0	GND	3.4
Q310	6.8	9.0	7.4
Q311	5.4	9.0	6.1
Q312	1.5	7.6	2.2
Q313	0.9	9.0	0.9
Q314	0.9	6.0	1.5
Q315	5.3	9.0	6.0
Q316	0	9.0	0
Q317	8.2	3.7	7.6
Q318	0.7	5.9	0.7
Q319	GND	0.3	0
Q320	1.2	6.1	1.8
Q321	5.4	9.0	6.1
Q322	2.5	9.0	3.2

M BOARD * MARK

Ref.No.	KP-41T15(L/C)	KP-46S15(L/C)	KP-53S15(L/C)
C350	10 50V	-	-
C354	22p	-	-
C355	22 50V	-	-
C357	47 25V	-	-
C358	15p	-	-
C359	70p	-	-
C360	10 50V	-	-
C361	10 50V	-	-
C362	22p	-	-
C363	0.001	-	-
C364	10 50V	-	-
ON314	6P	-	-
D320	MA110	-	-
D321	MA110	-	-
D322	MA110	-	-
D323	MA110	-	-
D324	MA110	-	-
D325	MA110	-	-
L302	22μH	-	-
L303	39μH	-	-
Q310	2SC2412K	-	-
Q312	2SC2412K	-	-
Q314	2SC2412K	-	-
Q315	2SC2412K	-	-
Q316	2SC2412K	-	-
Q317	2SC2412K	-	-
Q318	2SC2412K	-	-
Q319	2SC2412K	-	-
Q320	2SC2412K	-	-
Q321	2SC2412K	-	-
R348	1k	-	-
R352	2.2k	-	-
R353	6.8k	-	-
R356	180	-	-
R357	180	-	-
R359	330	-	-
R362	270	-	-
R363	1k	-	-
R364	100	-	-
R366	1.5k	-	-
R367	2.2k	-	-
R368	100	-	-
R369	3.3k	-	-
R371	1k	-	-

Ref.No.	KP-41T15(L/C)	KP-46S15(L/C)	KP-53S15(L/C)
R372	1.2k	-	-
R373	270	-	-
R374	33k	-	-
R375	12k	-	-
R376	68k	-	-
R377	560	-	-
R378	2.7k	-	-
R379	27k	-	-
R380	100k	-	-
R381	8.2k	-	-
R382	33k	-	-
R383	560	-	-
R384	1.5k	-	-
R385	33k	-	-
R386	1M	-	-
R387	1k	-	-
R388	0	-	-
R389	220	-	-

- - : NOT MOUNT

*** M BOARD WAVEFORMS**

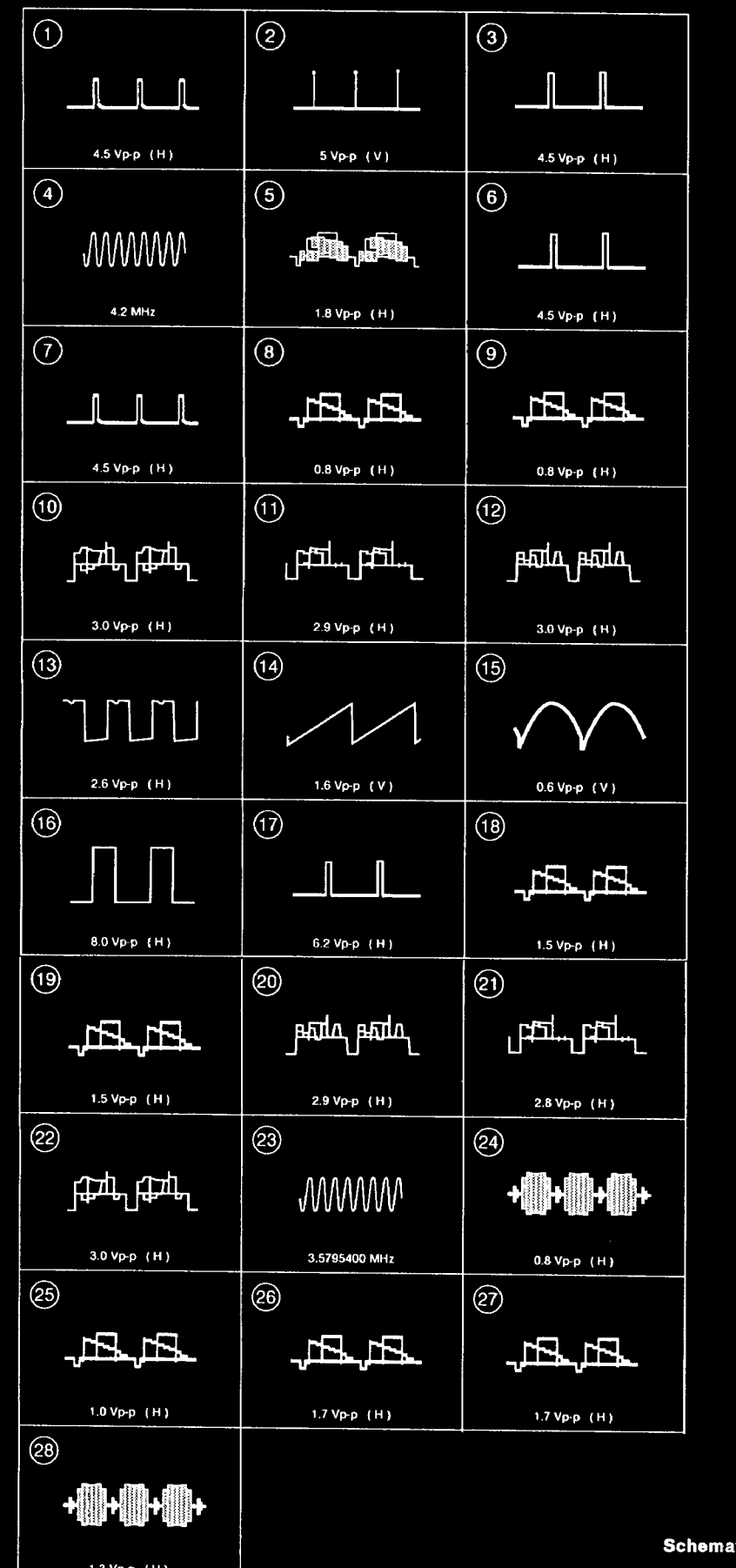

Schematic diagrams

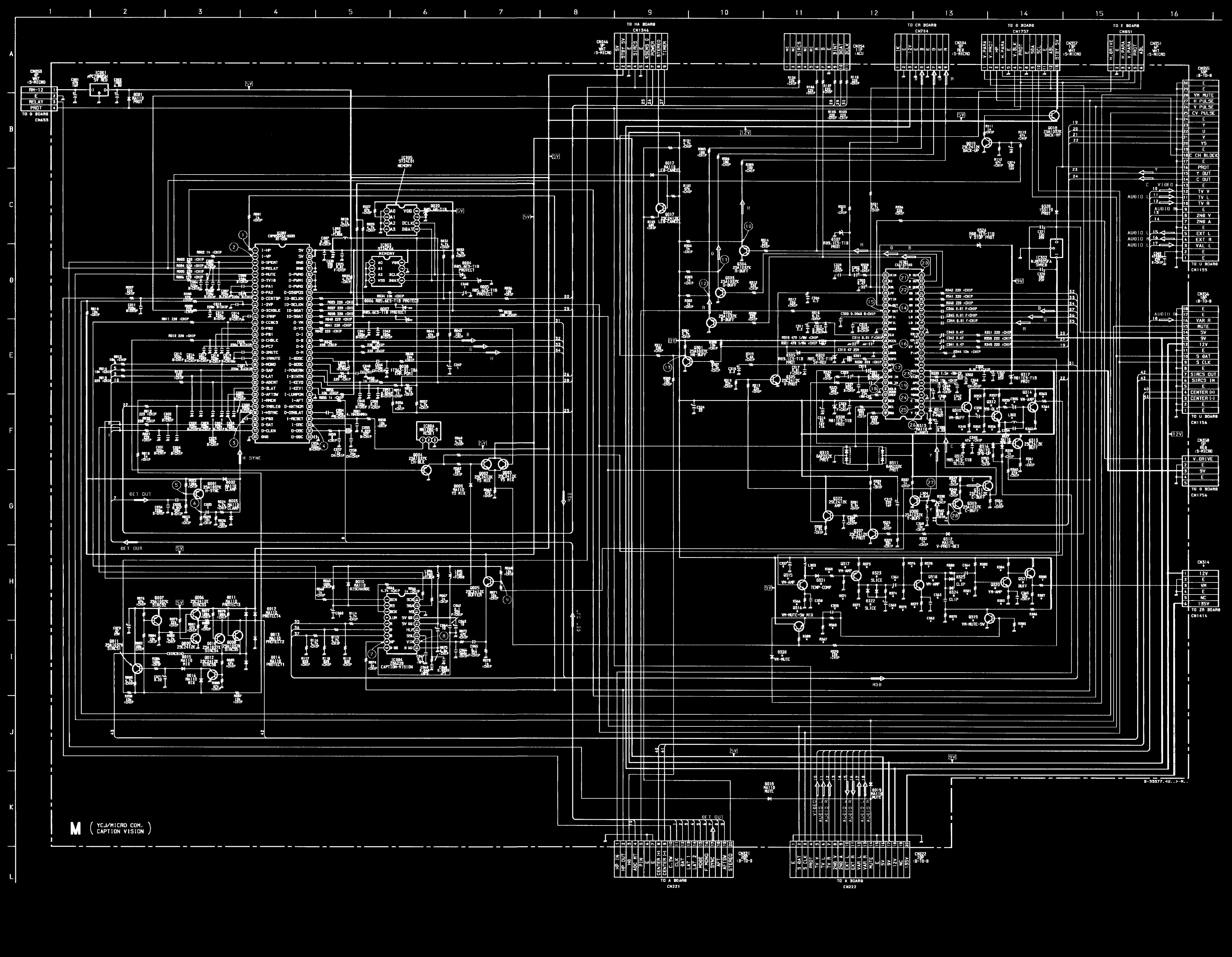

Schematic diagrams

SPECIFICATIONS

Projection system 3 picture tubes, 3 lenses, horizontal in-line system

Picture tube 7 inch high-brightness monochrome tubes (6.3 raster size), with optical coupling and liquid cooling system

Projection lenses High performance, large-diameter hybrid lens F1.0

Screen size (measured diagonally)

KP-41T15	41 inches
KP-46S15	46 inches
KP-53S15	53 inches

Screen brightness

KP-41T15	1900 cd/m ²
KP-46S15	1500 cd/m ²
KP-53S15	1200 cd/m ²

Television system American TV standards

Channel coverage VHF : 2-13 / UHF : 14-69 / CATV : 1-125

Antenna 75 ohm external antenna terminal for VHF/UHF

Inputs/output VIDEO IN 1
S VIDEO IN (4-pin mini DIN) :
Y : 1 Vp-p, 75-ohms
unbalanced, sync negative
C : 0.286 Vp-p (Burst signal) 75 ohms
VIDEO (phone jack) :
1 Vp-p, 75-ohms
unbalanced, sync negative
AUDIO (phone jacks) :
500 mVrms (100% modulation)
Impedance : 47 kilohms
VIDEO INPUT 2 and VIDEO IN 3
VIDEO (phone jacks) :
1 Vp-p, 75-ohms
unbalanced, sync negative
AUDIO (phone jacks) :
500 mVrms (100% modulation)
Impedance : 47 kilohms
MONITOR OUT
VIDEO (phone jack) :
1 Vp-p, 75-ohms
unbalanced, sync negative
AUDIO (phone jacks) :
500 mVrms (100% modulation)
Impedance : 10 kilohms
AUDIO OUT (phono jacks) :
900 mVrms (100% modulation)
Impedance : 5 kilohms

Speaker Full range speaker
100 mm (3.9 inches) diameter

Speaker output 7 W x 2

Power requirement 120 V, 60 Hz

Power consumption 220 W
Standby mode : 4 W

	Dimensions (W/H/D)	Mass
KP-41T15	950 x 1,000 x 588 mm (37 1/2 x 39 3/8 x 23 1/4 inches)	51 kg (112 lbs 7 oz)
KP-46S15	1,066 x 1,306 x 543 mm (41 3/4 x 51 1/2 x 21 1/2 inches)	70 kg (154 lbs 5 oz)
KP-53S15	1,218 x 1,413 x 594 mm (48 x 55 3/4 x 23 1/2 inches)	75 kg (165 lbs 6 oz)

Supplied accessories Remote commander RM-Y118 (1)
Size AA (R6) battery (1)

Optional accessories U/V mixer EAC-66
Connecting cables RK-74A,
VMC-810S/820S, YC-15V/30V,
VMC-720M
Video tray SU-PJT2 (For KP-46S15,
KP-53S15)
Stand SU-41X1 (For KP-41T15)
Contrast screen
SCN-41T1 (For KP-41T15)
SCN-46X1 (For KP-46S15)
SCN-53X1 (For KP-53S15)

Design and specifications are subject to change without notice.

SAFETY CHECK-OUT (US model only)

After correcting the original service problem, perform the following safety checks before releasing the set to the customer:

1. Check the area of your repair for unsoldered or poorly-soldered connections. Check the entire board surface for solder splashes and bridges.
2. Check the interboard wiring to ensure that no wires are "pinched" or contact high-wattage resistors.
3. Check that all control knobs, shields, covers, ground straps, and mounting hardware have been replaced. Be absolutely certain that you have replaced all the insulators.
4. Look for unauthorized replacement parts, particularly transistors, that were installed during a previous repair. Point them out to the customer and recommend their replacement.
5. Look for parts which, through functioning, show obvious signs of deterioration. Point them out to the customer and recommend their replacement.
6. Check the line cords for cracks and abrasion. Recommend the replacement of any such line cord to the customer.
7. Check the condition of the monopole antenna (if any). Make sure the end is not broken off, and has the plastic cap on it. Point out the danger of impalement on a broken antenna to the customer, and recommend the antenna's replacement.
8. Check the B+ and HV to see they are at the values specified. Make sure your instruments are accurate; be suspicious of your HV meter if sets always have low HV.
9. Check the antenna terminals, metal trim, "metallized" knobs, screws, and all other exposed metal parts for AC leakage. Check leakage as described below.

LEAKAGE TEST

The AC leakage from any exposed metal part to earth ground and from all exposed metal parts to any exposed metal part having a return to chassis, must not exceed 0.5mA (500 microamperes). Leakage current can be measured by any one of three methods.

1. A commercial leakage tester, such as the Simpson 229 or RCA WT-540A. Follow the manufacturers' instructions to use these instruments.
2. A battery-operated AC milliammeter. The Data Precision 245 digital multimeter is suitable for this job.
3. Measuring the voltage drop across a resistor by means of a VOM or battery-operated AC voltmeter. The "limit" indication is 0.75V, so analog meters must have an accurate low-voltage scale. The Simpson 250 and Sanwa SH-63Trd are examples of a passive VOM that is suitable. Nearly all battery operated digital multimeters that have a 2V AC range are suitable. (See Fig. A)

HOW TO FIND A GOOD EARTH GROUND

A cold-water pipe is guaranteed earth ground; the cover-plate retaining screw on most AC outlet boxes is also at earth ground. If the retaining screw is to be used as your earth-ground, verify that it is at ground by measuring the resistance between it and a cold-water pipe with an ohmmeter. The reading should be zero ohms. If a cold-water pipe is not accessible, connect a 60-100 watts trouble light (not a neon lamp) between the hot side of the receptacle and the retaining screw. Try both slots, if necessary, to locate the hot side of the line, the lamp should light at normal brilliance if the screw is at ground potential. (See Fig. B)

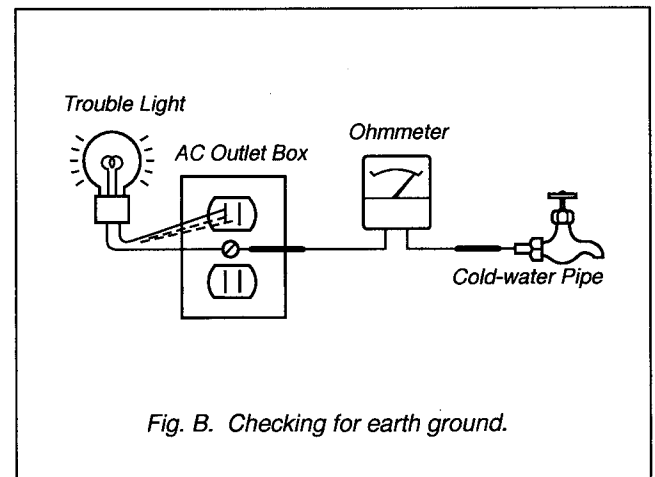
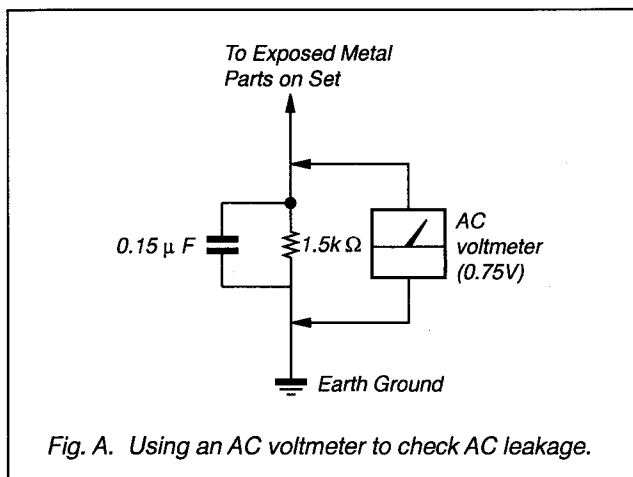

TABLE OF CONTENTS

<u>Section</u>	<u>Title</u>	<u>Page</u>	<u>Section</u>	<u>Title</u>	<u>Page</u>
1. GENERAL					
Step 1 :	Installing the projection TV	5	2-10-2.	MIRROR COVER REMOVAL (KP-46S15/53S15)	19
Step 2 :	Connections	5	2-11.	HIGH-VOLTAGE CABLE INSTALLATION AND REMOVAL	19
Step 3 :	Setting up the remote commander	8	2-12.	PICTURE TUBE REMOVAL	19
Step 4 :	Setting up the projection TV automatically (AUTO SET UP)	8	3. SAFETY RELATED ADJUSTMENTS		
Listening to	surround sound (SURROUND)	10	4. DIAGRAMS		
Selecting stereo or	bilingual programs (MTS)	10	4-1.	Block Diagrams (1)	26
Setting daylight saving	time (DAYLIGHT SAVING)	11		Block Diagrams (2)	31
Setting the clock (CURRENT	TIME SET)	11	4-2.	Circuit Boards Location	37
Setting the timer to turn	the projection		4-3.	Printed Wiring Board and Schematic Diagrams	37
TV on and off (ON/OFF	TIMER)	12		• A Board	41
Blocking out a channel (CHANNEL	BLOCK)	12		• D Board	45
Customizing the channel	number buttons (CH CAPTION/GUIDE)	13		• U Board	53
Setting video labels (VIDEO	LABEL)	13		• M Board	57
Displaying Caption Vision (CAPTION	VISION/XDS)	14		• P Board	65
Operating video equipment		14		• HA Board	71
Operating a cable box		15		• E Board	72
2. DISASSEMBLY					
2-1-1.	REAR PLATE REMOVAL (KP-41T15)	16		• G Board	79
2-1-2.	REAR PLATE REMOVAL (KP-46S15/53S15)	16		• ZB Board	82
2-2.	CHASSIS ASSY REMOVAL	16		• ZG Board	83
2-3.	SERVICE POSITION	16		• ZR Board	84
2-4.	G BOARD REMOVAL	17		• CR Board	88
2-5.	D BOARD REMOVAL	17		• CG Board	90
2-6.	U BOARD REMOVAL	17		• CB Board	91
2-7.	M BOARD REMOVAL	17	4-4.	Semiconductors	94
2-8-1.	HA BOARD REMOVAL (KP-41T15)	18	5. EXPLODED VIEWS		
2-8-2.	HA BOARD REMOVAL (KP-46S15/53S15)	18	5-1.	Cover (KP-41T15)	96
2-9-1.	BEZNET REMOVAL (KP-41T15)	18	5-2.	Cover (KP-46S15/53S15)	97
2-9-2.	BEZNET REMOVAL (KP-46S15/53S15)	18	5-3.	Chassis	98
2-10-1.	MIRROR COVER REMOVAL (KP-41T15)	19	5-4.	Picture tube	99
6. ELECTRICAL PARTS LIST					
100					

(CAUTION)

SHORT CIRCUIT THE ANODE OF THE PICTURE TUBE AND THE ANODE CAP TO THE METAL CHASSIS, CRT SHIELD, OR CARBON PAINTED ON THE CRT, AFTER REMOVING THE ANODE.

WARNING!!

AN ISOLATION TRANSFORMER SHOULD BE USED DURING ANY SERVICE TO AVOID POSSIBLE SHOCK HAZARD, BECAUSE OF LIVE CHASSIS.

THE CHASSIS OF THIS RECEIVER IS DIRECTLY CONNECTED TO THE AC POWER LINE.

SAFETY-RELATED COMPONENT WARNING!!

COMPONENTS IDENTIFIED BY SHADING AND MARK Δ ON THE SCHEMATIC DIAGRAMS, EXPLODED VIEWS AND IN THE PARTS LIST ARE CRITICAL TO SAFE OPERATION. REPLACE THESE COMPONENTS WITH SONY PARTS WHOSE PART NUMBERS APPEAR AS SHOWN IN THIS MANUAL OR IN SUPPLEMENTS PUBLISHED BY SONY. CIRCUIT ADJUSTMENTS THAT ARE CRITICAL TO SAFE OPERATION ARE IDENTIFIED IN THIS MANUAL. FOLLOW THESE PROCEDURES WHENEVER CRITICAL COMPONENTS ARE REPLACED OR IMPROPER OPERATION IS SUSPECTED.

(ATTENTION)

APRES AVOIR DECONNECTE LE CAP DE L'ANODE, COURT-CIRCUITER L'ANODE DU TUBE CATHODIQUE ET CELUI DE L'ANODE DU CAP AU CHASSIS METALLIQUE DE L'APPAREIL, OU AU COUCHE DE CARBONE PEINTE SUR LE TUBE CATHODIQUE OU AU BLINDAGE DU TUBE CATHODIQUE.

ATTENTION!!

AFIN D'EVITER TOUT RISQUE DELECTROCUTION PROVENANT D'UN CHASSIS SOUS TENSION, UN TRANSFORMATEUR D'ISOLEMENT DOIT ETRE UTILISE LORS DE TOUT DEPANNAGE. LE CHASSIS DE CE RECEPTEUR EST DIRECTEMENT RACCORDE A L'ALIMENTATION SECTEUR.

ATTENTION AUX COMPOSANTS RELATIFS A LA
SECURITE!!

LES COMPOSANTS IDENTIFIES PAR UNE TRAME ET PAR UNE MAPQUE Δ SUR LES SCHEMAS DE PRINCIPE, LES VUES EXPLOSEES ET LES LISTES DE PIECES CONT D'UNE IMPORTANCE CRITIQUE POUR LA SECURITE DU FONCTIONNEMENT. NE LES REMPLACER QUE PAR DES COMPOSANTS SONY DONT LE NUMERO DE PIECE EST INDIQUE DANS LE PRESENT MANUEL OU DANS DES SUPPLEMENTS PUBLIES PAR SONY. LES REGLAGES DE CIRCUIT DONT L'IMPORTANCE EST CRITIQUE POUR LA SECURITE DU FONCTIONNEMENT SONT IDENTIFIES DANS LE PRESENT MANUEL. SUIVRE CES PROCEDURES LORS DE CHAQUE REMPLACEMENT DE COMPOSANTS CRITIQUES, OU LORSQU'UN MAUVAIS FONCTIONNEMENT EST SUSPECTE.

SECTION 1 GENERAL

The operating instructions mentioned here are partial abstracts from the Operating Instruction Manual. The page numbers of the Operating Instruction Manual remain as in the manual.

Getting Started

Step 1: Installing the projection TV

For the best picture quality, install the projection TV within the areas shown below.

Optimum viewing area (Horizontal)

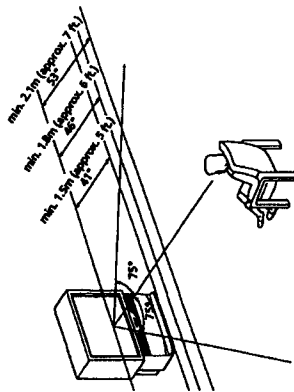

Optimum viewing area (Vertical)

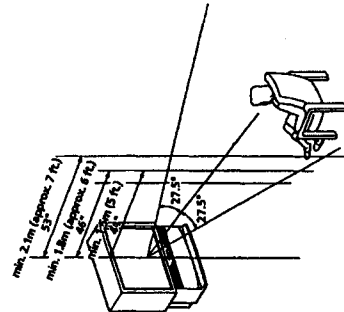

Carrying your projection TV

Be sure to grasp the portions indicated when carrying the projection TV, and to use more than two people.

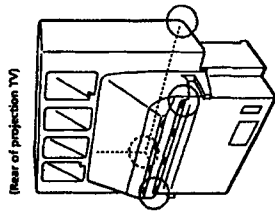

Preparing for your projection TV

Before you use your projection TV, adjust convergence. For the procedure, see "Step 4: Setting up the projection TV automatically (AUTO SET UP)" on page 12.

Step 2: Connections

Although you can use either an indoor antenna or outdoor antenna with your projection TV, we recommend connecting to an outdoor antenna or a cable TV system for improved picture quality.

To an antenna

Connect your antenna cable to the VHF/UHF antenna terminal. If you cannot connect your antenna cable directly to the terminal, follow one of the instructions below depending on your cable type.

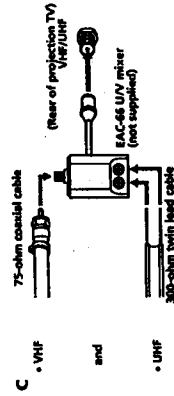

Notes

- Most VHF/UHF combination antennas have a signal splitter. Remove the splitter before attaching the appropriate connector.
- If you use the L/V mixer, snow and noise may appear in the picture when viewing cable TV channels over 37(W+1).

Connecting an antenna/cable TV system without a VCR

To cable or antenna



To cable box

If your cable company requires you to connect a cable box, make the connection as follows:

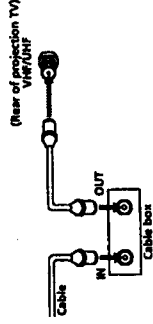

Connecting an antenna/cable TV system with a VCR

For details on connection, see the instruction manual of your VCR. Before connecting, disconnect the AC power cords of the equipment to be connected.

- After making these connections, you will be able to do the following:
- View the playback of video tapes
 - Record one TV program while viewing another program
 - Watch two TV programs at one time using a window picture (Picture-in-Picture)

To a conventional VCR

Without a cable box

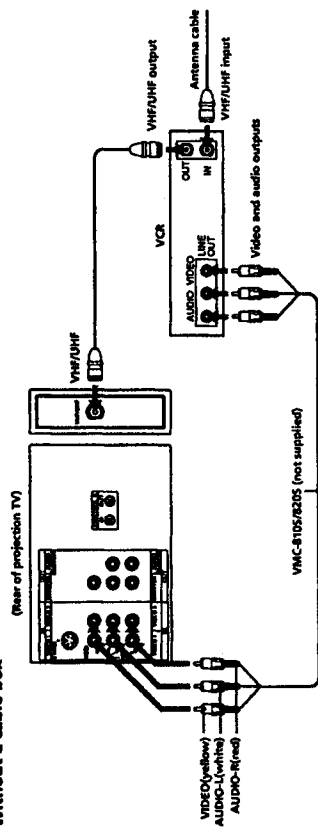

- Note**
- To connect a monaural VCR, connect the audio output of the VCR to AUDIO-L (MONO) or VIDEO 1/3 IN on the projection TV.

With a cable box

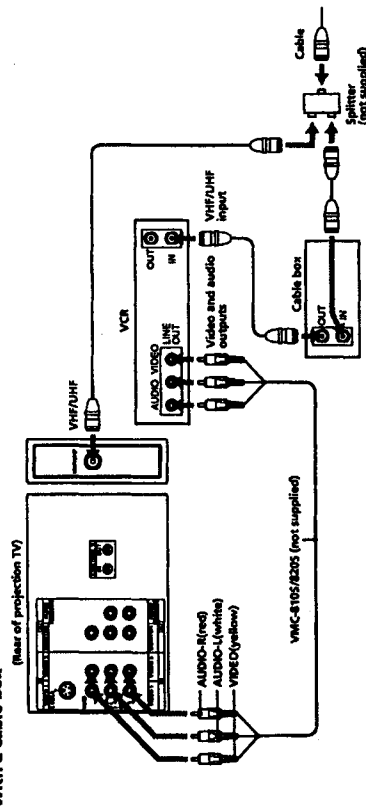

To an S video equipped VCR

If your VCR has an S video output jack, make the connection as follows.

Whenever you connect the cable to the S VIDEO connector, the projection TV automatically receives S video signals.

Without a cable box

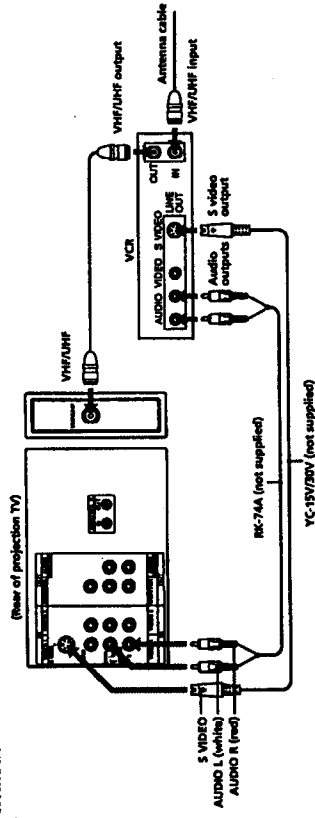

- Note**
- Video signals are composed of Y (luminance) and C (chroma) signals. The S connection sends the two signals separately preventing degradation, and gives better picture quality compared to conventional connection.

With a cable box

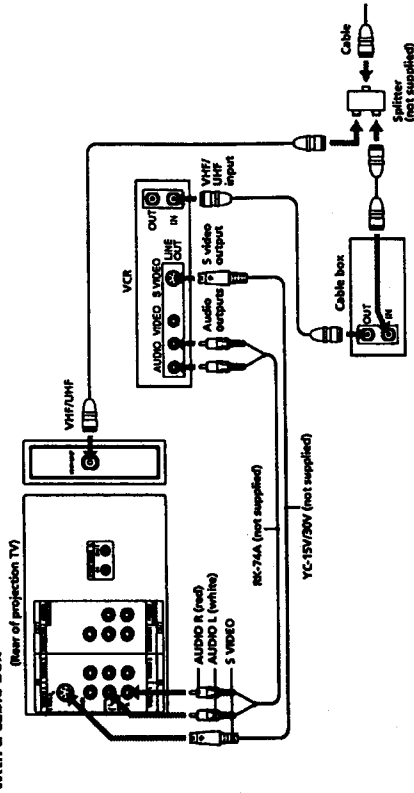

Connecting a camcorder

This connection is convenient for watching the picture from a camcorder.

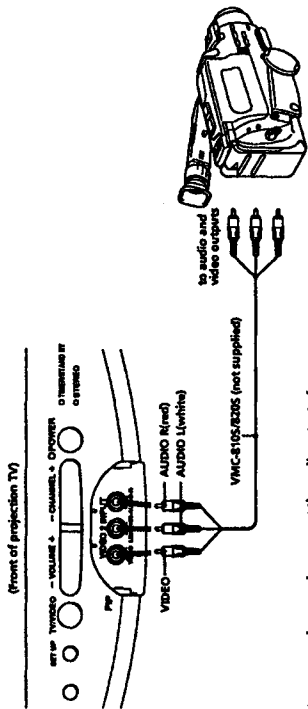

Note

- To connect a monaural camcorder, connect the audio output of the camcorder to AUDIO L (MONO) or VIDEO 2 INPUT on the projection TV.

Connecting two VCRs for tape editing

You can record input images displayed on the screen. This type of connection should be used only when you connect from the line input of one VCR, and from the line output of a second VCR.

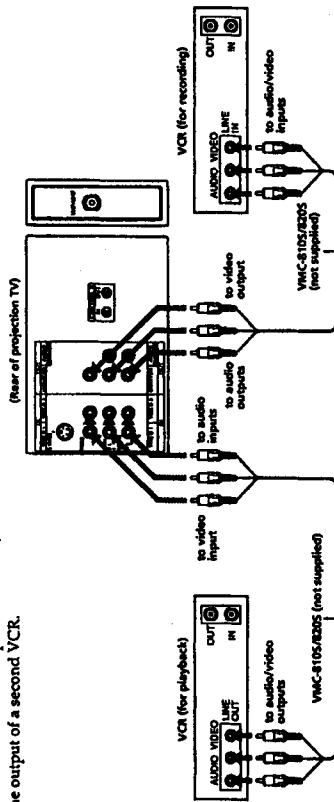

Notes

- Do not change the input signal while editing, or the output signal will also change.
- When connecting a single VCR to the projection TV, do not connect MONITOR OUT to the VCR's line input, while at the same time connecting from the projection TV's VIDEO IN jacks to the VCR's line output.
- You can use the S video connector to connect a VCR for playback and the composite video jack to connect a VCR for recording.

Connecting an audio system

When connecting audio equipment, see page 24 for more information.

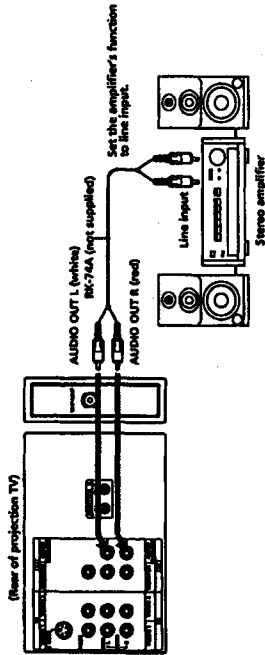

Note

- You can adjust the bass, treble and balance, or select surround or an MTS (Multichannel TV Sound) mode with the supplied remote commander.

Connecting other Sony equipment with CONTROL S jack

This feature allows you to control your projection TV and other Sony equipment with one remote commander.

- To control other Sony equipment with the projection TV's remote commander, connect the input of the equipment to CONTROL S OUT jack on the projection TV.
- To control the projection TV with the remote commander of other Sony equipment, connect the output of the equipment to CONTROL S IN jack on the projection TV.

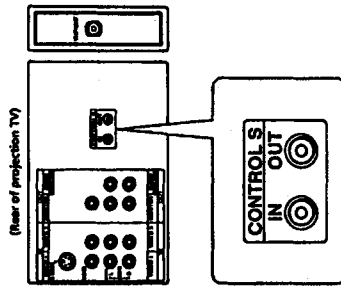

Step 3: Setting up the remote commander

Insert one size AA (R6) battery (supplied) by matching the + and - on the battery to the diagram inside the battery compartment.

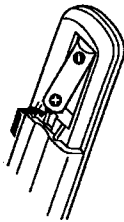

- Notes**
- With normal use, the battery should last for approximately six months.
 - If you do not use the remote commander for an extended period of time, remove the battery to avoid possible damage from battery leakage.
 - Do not handle the remote commander roughly. Do not drop it, step on it or let it get wet.
 - Do not place the remote commander in direct sunlight, near a heater, or where the humidity is high.

Step 4: Setting up the projection TV automatically (AUTO SET UP)

You can set up your projection TV easily by using AUTO SET UP feature. It presets all the receivable channels, adjusts the convergence and changes the on-screen menu language. To set up the TV manually, see "Presetting channels" (page 15), "Setting cable TV on or off" (page 14), "Adjusting convergence" (page 13) and "Changing the menu language" (page 15). If the TV is set to a video input, you cannot execute AUTO SET UP. Press TV/VIDEO so that a channel number appears.

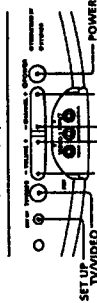

1 Press POWER to turn the projection TV on.



2 Press SET UP on the front of the projection TV.



AUTO SET UP : [CH-]
 AUTO ADJUSTS : [CH-]
 RESCALE AUTO : [VOL-]
 DEMO : [VOL-]
 Press RETURN to Exit

3 Press CHANNEL+ to start AUTO SET UP.
 If you prefer Spanish or French to English, you can change the on-screen menu language. Press CHANNEL- for Spanish or VOLUME+ for French.



CONTINUE TO PROGRAM
 AUTO : [CH-]
 YES : [CH-]
 NO : [CH-]

All of the menus will be set to the factory preset condition in the selected language.

(continued) **Getting Started 11-EN**

4 Press CHANNEL+ to preset channels.

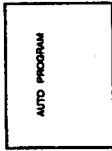

"AUTO PROGRAM" appears on the screen and the TV starts scanning and presetting channels automatically. When all the receivable channels are stored, "AUTO PROGRAM" disappears and the following menu appears. If the projection TV receives cable TV channels, CA-TV is set to ON automatically.

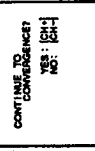

5 Adjust convergence.

(1) Press CHANNEL+.
 The CONVERGENCE adjustment screen appears.

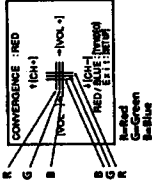
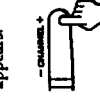

(2) Press TV/VIDEO to select RED or BLUE.

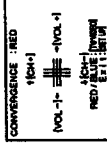

(3) Using CHANNEL+/- or VOLUME+/-, move the line until it converges with the center green line.

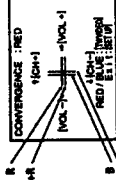
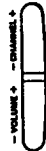

To move horizontal line up/down, press CHANNEL+/-.
 To move vertical line right/left, press VOLUME+/-.

(4) Repeat steps (2) and (3) to adjust the other lines until all three lines converge and are seen as a white cross.

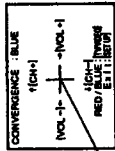

Note

- If more than 90 seconds elapse after you press a button, the menu disappears automatically.

To preview the main functions (DEMO) Press VOLUME- in step 3. The functions and menus are displayed one by one.

Erasing or adding channels

After AUTO SET UP you can erase unnecessary channels or add the channels you want. Preset channels during the day rather than late at night, when some channels may not be broadcasting.

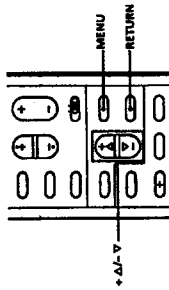

1 Press MENU.

The main menu appears.

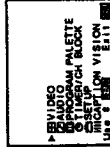

2 Press + Δ or - ∇ to move the cursor (▶) to SET UP and press RETURN.

The SET UP menu appears.

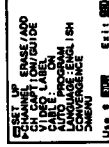

- 3** Make sure the cursor (P) is beside CHANNEL ERASE/ADD and press RETURN.
- If the cursor is not beside CHANNEL ERASE/ADD, press + Δ or - ∇ to move the cursor and the CHANNEL ERASE/ADD menu appears.



- 4** Erase and/or add the channel you want:

- Make sure the cursor (P) is beside ERASE.
- Press CH + or - to select the channel you want to erase.

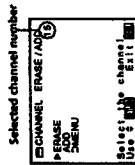

- (3)** Press RETURN.

The indication "-" appears beside the channel number, showing that the channel is erased from the preset memory.



- To add a channel that you want
- Press + Δ or - ∇ to select ADD.
 - Press 0-9 button to select the channel you want to add and press ENTER.

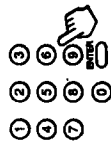
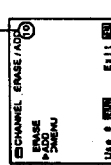

- (3)** Press RETURN.
- The indication "+" appears beside the channel number, showing that the channel is added to the preset memory.



- 5** To erase and/or add other channels, repeat step 4.
- 6** When you finish, press MENU.



Notes

- If you erase or add a VHF or UHF channel, the cable TV channel with the same number is also erased or added, and vice versa.
- If more than 90 seconds elapse after you press a button, the menu disappears automatically.

Adjusting convergence (CONVERGENCE)

The projection tube image appears on the screen in three layers (red, green and blue). If they do not converge, the color is poor and the picture blurs. To correct this, adjust convergence.

You do not have to do this procedure if you execute AUTO SET UP (page 11). Do this procedure only when you want to adjust it manually.

- 1** Press MENU.

- 2** Press + Δ or - ∇ to move the cursor (P) to SET UP and press RETURN.

(continued)

- 3** Press + Δ or - ∇ to move the cursor (P) to CONVERGENCE and press RETURN.
- The CONVERGENCE adjustment screen appears.

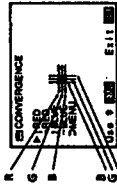

- 4** Press + Δ or - ∇ to move the cursor (P) to the symbol showing the line you want to adjust, and press RETURN.



- ! RED : Red vertical line (left/right adjustment)
 !-RED : Red horizontal line (up/down adjustment)
 ! BLUE : Blue vertical line (left/right adjustment)
 !-BLUE : Blue horizontal line (up/down adjustment)

- 5** Press + Δ or - ∇ to move the line until it converges with the center green line, and press RETURN.

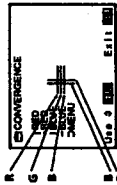

To move up/right, press + Δ.
 To move down/left, press - ∇.

- 6** Repeat steps 4 and 5 to adjust other lines until all three lines converge and are seen as a white cross.

- 7** Press MENU to return to the original screen.

Setting cable TV on or off

If you have connected the projection TV to a cable TV system, set CABLE to ON, the factory setting. If not, set CABLE to OFF.

You do not have to do this procedure if you execute AUTO SET UP (page 11). Do this procedure only when you want to set it manually.

- 1** Press MENU.

- 2** Press + Δ or - ∇ to move the cursor (P) to SET UP and press RETURN.

- 3** Press + Δ or - ∇ to move the cursor (P) to CABLE and press RETURN.



- 4** Press + Δ or - ∇ to select ON or OFF and press RETURN.

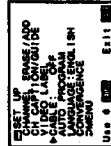

- 5** Press MENU to return to the original screen.

Note

- If CABLE appears in black, the projection TV is set to a video input and you cannot select CABLE. Press TV on the remote commander so that a channel number appears.

Setting daylight saving time (DAYLIGHT SAVING)

If your area uses daylight saving time, change DAYLIGHT SAVING setting depending on the season, before setting the current time.

Daylight saving start

- After the first Sunday in April, set DAYLIGHT SAVING to YES. Current time (page 26), On/off Timer (page 27) and Channel Block (page 28) settings automatically move one hour ahead.

Daylight saving end

- After the last Sunday in October, set DAYLIGHT SAVING to NO. Current time, On/off Timer and Channel Block settings automatically move one hour back.

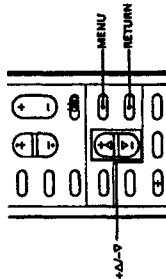

1 Press MENU.

2 Press + Δ or - ∇ to move the cursor (P) to TIMER/CH BLOCK and press RETURN.

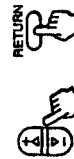
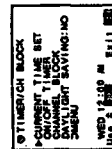

3 Press + Δ or - ∇ to select DAYLIGHT SAVING and press RETURN.

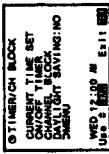

4 Press + Δ or - ∇ to select YES or NO and press RETURN.

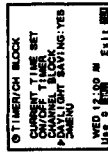

Choice	To
YES	Set for daylight saving start
NO	Set for daylight saving end

Setting the clock (CURRENT TIME SET)

Set the current time before using On/off Timer (page 27) and Channel Block features (page 28). For example, set the clock to 3:15 p.m., Monday.

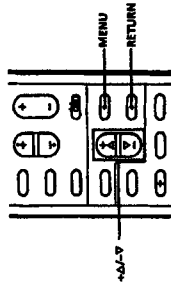

1 Press MENU.

2 Press + Δ or - ∇ to select TIMER/CH BLOCK and press RETURN.

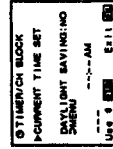

If you need to set DAYLIGHT SAVING, follow the procedure on the previous page.

3 Make sure the cursor (P) is beside CURRENT TIME SET, and press RETURN.

If the cursor is not beside CURRENT TIME SET, press + Δ or - ∇ to move the cursor and press RETURN.

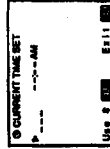

4 Set the current time.
 (1) Press RETURN to start setting the time.

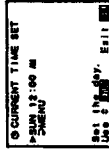

(2) Press + Δ or - ∇ to set the day and press RETURN.

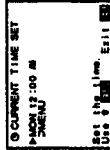

(3) Using + Δ or - ∇ and RETURN, set hour and minute in the same way as in step (2). When you press RETURN after setting the minute, the clock starts.



If you make a mistake while setting the time Press RESET while the CURRENT TIME SET menu is displayed, then repeat step 4.

To display the current time Press DISPLAY.

Note

- If you unplug the projection TV or a power interruption occurs, the clock will be erased. Reset the current time.

Setting the timer to turn the projection TV on and off (ON/OFF TIMER)

You can set the projection TV to turn on and off at the time you specify. Make sure the clock is set correctly. If it is not, set the clock first.

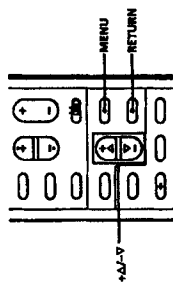

- 1 Press MENU.
- 2 Press + Δ or - ∇ to select **TIMER/CLOCK BLOCK** and press RETURN.
- 3 Press + Δ or - ∇ to select **ON/OFF TIMER** and press RETURN.

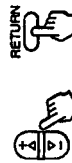
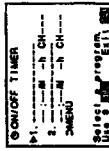

- 4 Enter the **ON/OFF TIMER** setting.
 - (1) Press + Δ or - ∇ to select program 1 or 2 and press RETURN.

(2) Press + Δ or - ∇ to set the days and press RETURN. Each time you press + Δ or - ∇, the days cycle as shown below.

EVERY SUN-SAT → EVERY MON-FRI → SUNDAY → MONDAY → ... → SATURDAY → EVERY SUNDAY → EVERY MONDAY → ... → EVERY SATURDAY

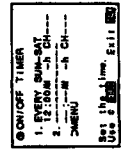

- (3) Press + Δ or - ∇ to set the time (hour then minute) that you want to turn on the projection TV and press RETURN.

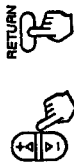
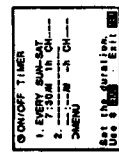

- (4) Press + Δ or - ∇ to set the hour duration and press RETURN. You can set the hour duration by one hour up to a maximum of six hours.

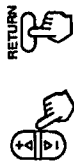
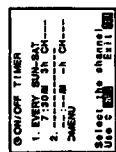

- (5) Press + Δ or - ∇ to select the channel and press RETURN.

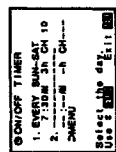

The **TIMER/STAND BY** indicator on the projection TV lights.

- 5 To set the other program, press RETURN and repeat step 4.

One minute before the projection TV switches to turn off, a message "TV will turn off." is displayed on the screen.

To cancel the timer
Press RESET on the remote commander.

Note
• If you unplug the projection TV or a power interruption occurs, ON/OFF TIMER settings will be erased. Reset the current time, then set the timer.

Blocking out a channel (CHANNEL BLOCK)

This feature allows you to prevent children from watching unsuitable programs. Make sure the clock is set correctly. If it is not, set the clock first (page 26).

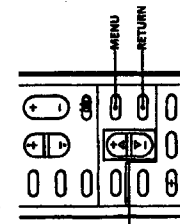

- 1 Press MENU.
- 2 Press + Δ or - ∇ to select **TIMER/CLOCK BLOCK** and press RETURN.
- 3 Press + Δ or - ∇ to select **CHANNEL BLOCK** and press RETURN.

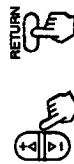
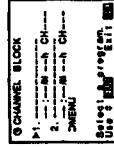

- 4 Enter a **CHANNEL BLOCK** setting.
 - (1) Press + Δ or - ∇ to select program 1 or 2 and press RETURN.

(2) Press + Δ or - ∇ to set the days and press RETURN. Each time you press + Δ or - ∇, the days cycle as shown below.

EVERY SUN-SAT → EVERY MON-FRI → SUNDAY → MONDAY → ... → SATURDAY → EVERY SUNDAY → EVERY MONDAY → ... → EVERY SATURDAY

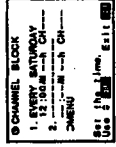

- (3) Press + Δ or - ∇ to set the time (hour then minute) that you want to start blocking the channel and press RETURN.

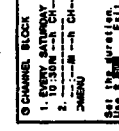

- (4) Press + Δ or - ∇ to select the hour duration you want to block and press RETURN. Each time you press RETURN, the hour duration increases by one hour up to a maximum of 12 hours.

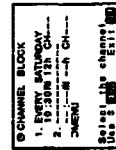

- (5) Press + Δ or - ∇ to select the channel and press RETURN.

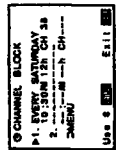

If you select the blocked channel during the time you set, the message "BLOCKED" appears and the picture is blocked and the sound is muted.

To cancel a **CHANNEL BLOCK** setting
Press RESET on the remote commander.

Note
• If the **CHANNEL BLOCK** and **ON/OFF TIMER** settings are overlapped, the later time setting has priority over the other setting.

Setting video labels (VIDEO LABEL)

This feature allows you to label each input mode so that you can easily identify the connected equipment. For example, you can label VIDEO 1 IN as VHS.

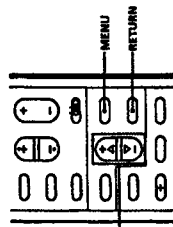

- 1 Press MENU.
- 2 Press + Δ or - ∇ to select SET UP and press RETURN.
- 3 Press + Δ or - ∇ to select VIDEO LABEL and press RETURN.

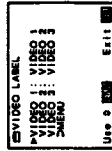

- 4 Press + Δ or - ∇ to select the input mode you want to label and press RETURN.

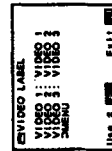

- 8 Repeat steps 4 to 7 to caption other channels.

To erase a caption Press RESET after step 4.

- Notes**
- The position number you already selected appears in yellow.
 - If the CH CAPTION/GUIDE menu appears in black, the projection TV is set to a video input, and you cannot select CH CAPTION/GUIDE. Press TV so that a channel number appears.
 - If more than 90 seconds elapse after you press a button, the menu disappears automatically.

Selecting a captioned channel

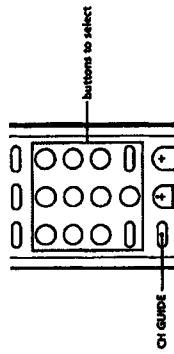

- 1 Press CH GUIDE. The CHANNEL GUIDE menu appears showing channel captions and the corresponding channel number buttons.

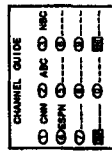

- 2 Press a channel number button, the DISPLAY or ENTER button to select the channel you want.

To cancel the CHANNEL GUIDE menu Press CH GUIDE again.

- 5 Press + Δ or - ∇ to select a channel guide number button and press RETURN. Each time you press + Δ or - ∇, the channel positions change to red in turns. The channel number button you select will be the one you press to call up your favorite channel.

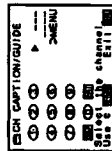

- 6 Press + Δ or - ∇ to select the channel that you want to caption and press RETURN.

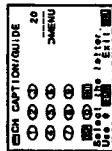

- 7 Enter the letters or numbers (up to four) to caption the channel:

(1) Press + Δ or - ∇ to select the first letter (number).
Each time you press + Δ or - ∇, the letter (number) changes as shown below.

0-1-2-3-4-5-6-7-8-9-A-B-C-D-E-F-G-H-I-J-K-L-M-N-O-P-Q-R-S-T-U-V-W-X-Y-Z-#-* / _ _ _ _ _ (blank space)



- (2) Press RETURN.

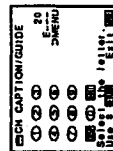

- (3) Repeat steps (1) and (2) to select the remaining letters (numbers) and press RETURN.

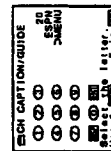

(continued) Operations 29-EN

Customizing the channel number buttons (CH CAPTION/ GUIDE)

You can choose up to 12 channels, caption each channel, and assign a specific channel number button to each channel. This feature allows you to select your favorite channels easily by name. For example, you can name channel 20 "ESPN," and assign the channel number 4 button to it.

Setting captions to favorite channels

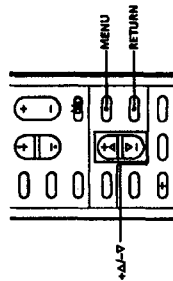

- 1 Press MENU.
- 2 Press + Δ or - ∇ to select SET UP and press RETURN.
- 3 Press + Δ or - ∇ to select CH CAPTION/GUIDE and press RETURN.

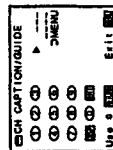

- 4 Press RETURN again.

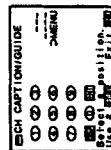

- 5** Press + Δ or - ∇ to select the label and press RETURN.



Each time you press + Δ or - ∇, the label changes as shown below.

VIDEO 1 → S-VIDEO → BETA → 8mm → VHS → LD → DSS

VIDEO 2 → BETA → 8mm → VHS → LD → DSS

VIDEO 3 → BETA → 8mm → VHS → LD → DSS

- 6** Repeat steps 4 and 5 to label other input modes.

Note

- If more than 30 seconds elapse after you press a button, the menu disappears automatically.

Displaying Caption Vision (CAPTION VISION)/XDS

Some programs are broadcast with Caption Vision. To display Caption Vision, select either CC1, CC2, CC3, CC4, TEXT1, TEXT2, TEXT3 or TEXT4 from the menu. CC1, CC2, CC3 or CC4 shows you a caption, that is a printed version of the dialog or sound effects of a program. (The mode should be set to CC1 for most programs.)

TEXT1, TEXT2, TEXT3 or TEXT4 shows you text, that is information presented using either half or the whole screen. It is not usually related to the program.

- 1** Press MENU.

- 2** Press + Δ or - ∇ to select CAPTION VISION/ XDS and press RETURN.



- 3** Press + Δ or - ∇ to select the caption type and press RETURN.

The selected caption type is colored green.



(continued)

To turn off the captions or text Press DISPLAY on the remote commander. Each time you press DISPLAY, the display changes as follows:

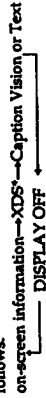

"DISPLAY OFF" goes off after three seconds.

* Some programs are broadcast with XDS service which shows a network name, program name, program length, call letters and time in show data. When you select XDS with the DISPLAY button, this information will be displayed on the screen if the broadcaster offers this service.

Note

- Captions may appear with a white box or another error instead of a certain word. Poor reception of TV programs can also cause errors in Closed Caption.

Operating video equipment

You can operate a piece of video equipment that has an infrared remote sensor with the supplied remote commander. Before operating, set the manufacturer's code number.

Setting the manufacturer's code

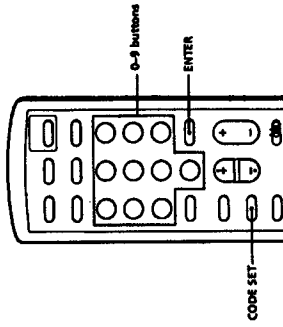

While pressing CODE SET, press 0 - 9 to enter the manufacturer's code number (see the chart in the right column) and press ENTER. For example, to operate a Sony 8 mm VCR, press 0, 2 and ENTER.



Manufacturer code numbers

Manufacturer	Code number
SONY	01, 02, 03, 04
CANON	05
EMERSON	22, 30, 33
FISHER	10, 11, 12, 15
FUNAI	29
GENERAL ELECTRIC	05, 08
GOLDSTAR	25
HITACHI	07, 08, 36
JVC	16, 35
MAGNAVOX	05, 06, 09
MITSUBISHI	18, 19, 26, 27
MULTITECH	29
NEC	16, 23, 31
PANASONIC	05, 06
PHILCO	05, 06
PHILIPS	05, 06, 09
QUASAR	05, 06
RCA	07, 08
SAMSUNG	24, 32
SANYO	11, 15
SCOTT	21
SHARP	13, 14
SHINTOM	34
SYLVANIA	05, 06, 09
SYMPHONIC	29
TEKNIKA	28, 29
TOSHIBA	20, 21
TOTE VISION	25
ZENITH	17

- Notes**
- If more than one code number is listed, try entering them one by one, until you come to the correct code for your equipment.
 - In some rare cases, you may not be able to operate your non-Sony video equipment with this remote commander. This is because your equipment may use a code that is not provided with this remote commander. In this case, please use the equipment's own remote control unit.
 - The code numbers for Sony equipment are assigned at the factory as follows:
 - Beta ED Beta VCRs 01
 - Beta VCR 02
 - VHS VCR 03 (preset code for this remote commander)
 - MDP 04
- Caution**
When you remove a battery from the remote commander, the code may revert to 01. Reset the codes each time you replace the battery, if necessary.

Operating video equipment

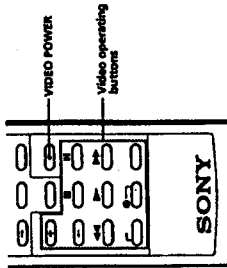

Use the video operating buttons on the remote commander to operate the video equipment.

Operating a VCR	Buttons on the remote commander
To turn on or off	Press VIDEO POWER
To change channels	Press CH +/-
To record	Press ● and REC simultaneously
To play	Press ▶
To stop	Press ■
To fast forward	Press ►►
To rewind the tape	Press ◄◄
To pause	Press II
To search the picture forward and backward	Press ►► or ◄◄ during playback

Operating a laser-disc player	Buttons on the remote commander
To play	Press ▶
To stop	Press ■
To pause	Press II
To resume normal playback, press again.	Press ►► or ◄◄
To search the picture forward and backward	Keep pressing ►► or ◄◄ during playback
To resume normal playback, release the button.	To resume normal playback, release the button.
To search the chapter forward and backward	Press CH +/-

Note
If the video equipment does not have a certain function, the corresponding button on this remote commander will not operate.

Operating a cable box

You can operate a connected cable box with the supplied remote commander. Before operating, set the manufacturer's code number.

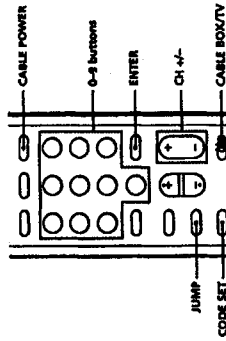

1 Set the CABLE BOX/TV selector to CABLE BOX.



2 While pressing CODE SET, press 0 - 9 to enter the manufacturer's code number (see the chart below) and press ENTER. For example, to operate a Zenith cable box, press 6 and 8 and press ENTER.



3 Use CABLE POWER and the projection TV control buttons (0 - 9, ENTER, JUMP and CH +/-) to operate the cable box.

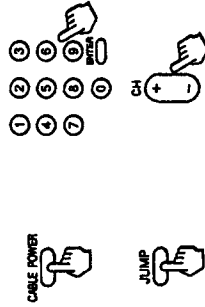

To operate the projection TV
Set the CABLE BOX/TV selector to TV. Then use the projection TV control buttons to control the projection TV.

For more details on operating the cable box
Refer to the operating instructions that come with the cable box.

Manufacturer	Code number
JERROLD	60, 61, 62, 63, 64, 65, 67
PIONEER	68, 70
SCIENTIFIC ATLANTA	66, 67
TOCCOM	71, 72
ZENITH	68

- Notes**
- If more than one code number is listed, try entering them one by one until you come to the correct code for your equipment.
 - If you enter a new code number, the code number you previously entered at that setting is erased.
 - In some rare cases, your equipment may use a code that is not provided with this remote commander and you may not be able to operate your cable box with the supplied remote commander. In this case, use the equipment's own remote control unit.
 - When you remove a battery from the remote commander, the code may be erased. Reset the code each time you replace the battery, if necessary.

**SECTION 2
DISASSEMBLY**

**2-1-1. REAR PLATE REMOVAL
(KP-41T15)**

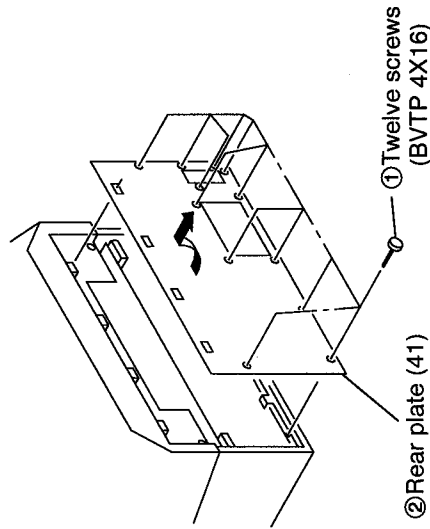

**2-1-2. REAR PLATE REMOVAL
(KP-46S15/53S15)**

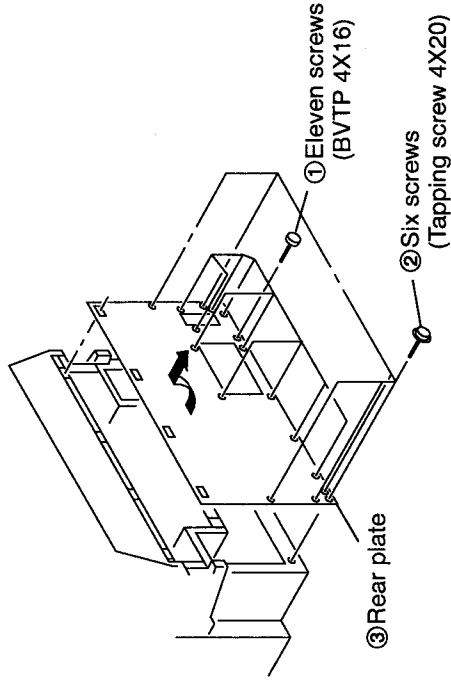

2-2. CHASSIS ASSY REMOVAL

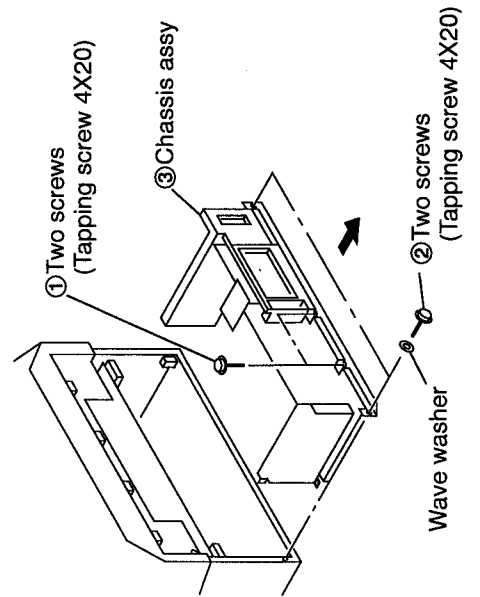

2-3. SERVICE POSITION

· Remove the chassis assy (Refer to 2-2.)

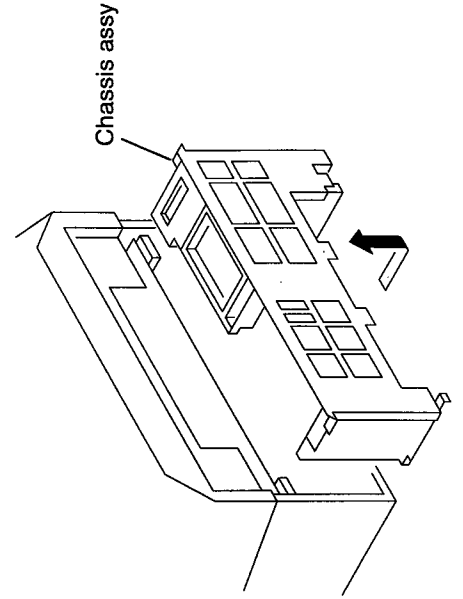

5-3. CHASSIS

- : 7-685-648-79 + BVTP 3×12
- : 7-685-663-79 + BVTP 4×16

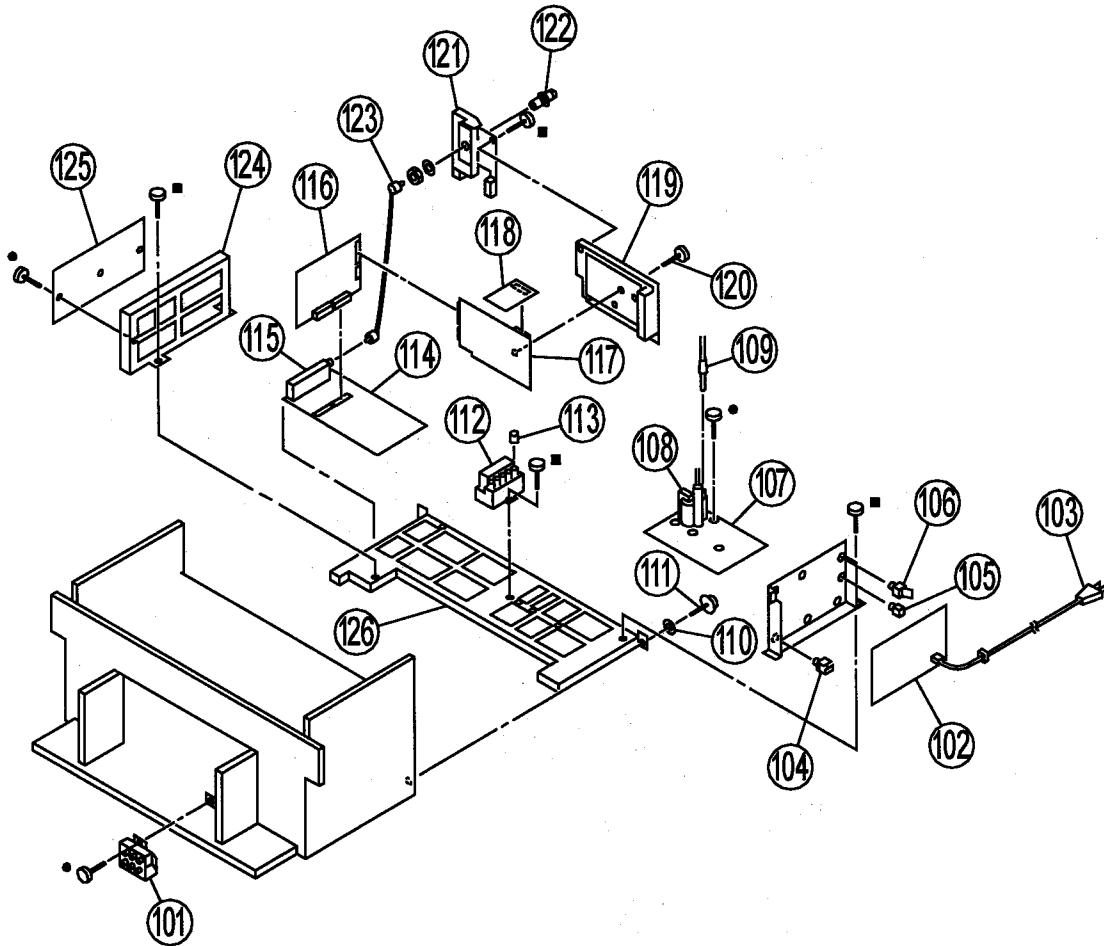

The components identified by shading and mark Δ are critical for safety. Replace only with part number specified.

Les composants identifiés par une trame et une marque Δ sont critiques pour la sécurité. Ne les remplacer que par une pièce portant le numéro spécifié.

REF.NO.	PART NO.	DESCRIPTION	REMARK	REF.NO.	PART NO.	DESCRIPTION	REMARK
101	Δ 1-223-925-11	RESISTOR ASSY (HIGH-VOLTAGE)		116	*A-1306-493-A	M BOARD, COMPLETE (KP-41T15)	
102	*A-1316-212-A	G BOARD, COMPLETE			*A-1306-498-A	M BOARD, COMPLETE (KP-46S15/53S15)	
103	Δ 1-769-837-11	CORD, POWER (WITH NOISE FILTER) 7.0A/125V		117	*A-1373-511-A	U BOARD, COMPLETE	
104	*3-659-682-11	HOLDER, PC BOARD		118	*A-1195-062-A	P BOARD, COMPLETE	
105	*4-382-848-01	HOLDER, PCB		119	4-047-951-01	TERMINAL BOARD (A)	
106	*3-703-141-00	HOLDER, PCB		120	4-041-165-01	SCREW (3X12), TAPPING, +BV	
107	*A-1341-885-A	E BOARD, COMPLETE		121	4-047-952-01	TERMINAL BOARD (B)	
108	Δ 8-598-939-00	TRANSFORMER ASSY, PLYBACK (MY-2631/A4S)		122	1-561-306-00	JACK, PIN (P)	
109	Δ 1-900-211-34	LEAD ASSY, HV		123	1-556-945-21	CABLE, P-P	
110	4-042-667-01	WASHER, WAVE		124	*4-047-950-01	BRACKET, D PC BOARD	
111	4-041-164-11	SCREW (4X20), TAPPING		125	*A-1346-296-A	D BOARD, COMPLETE	
112	Δ 8-598-955-00	BLOCK ASSY, HIGH VOLTAGE		126	*4-047-949-01	BRACKET, MAIN PC BOARD	
113	4-373-137-01	CAP (Z), RUBBER					
114	*A-1297-476-A	A BOARD, COMPLETE					
115	Δ 8-598-254-00	TUNER BTF-WA402					

5-4. PICTURE TUBE

■ : 7-685-663-79

+ BVTP 4x16

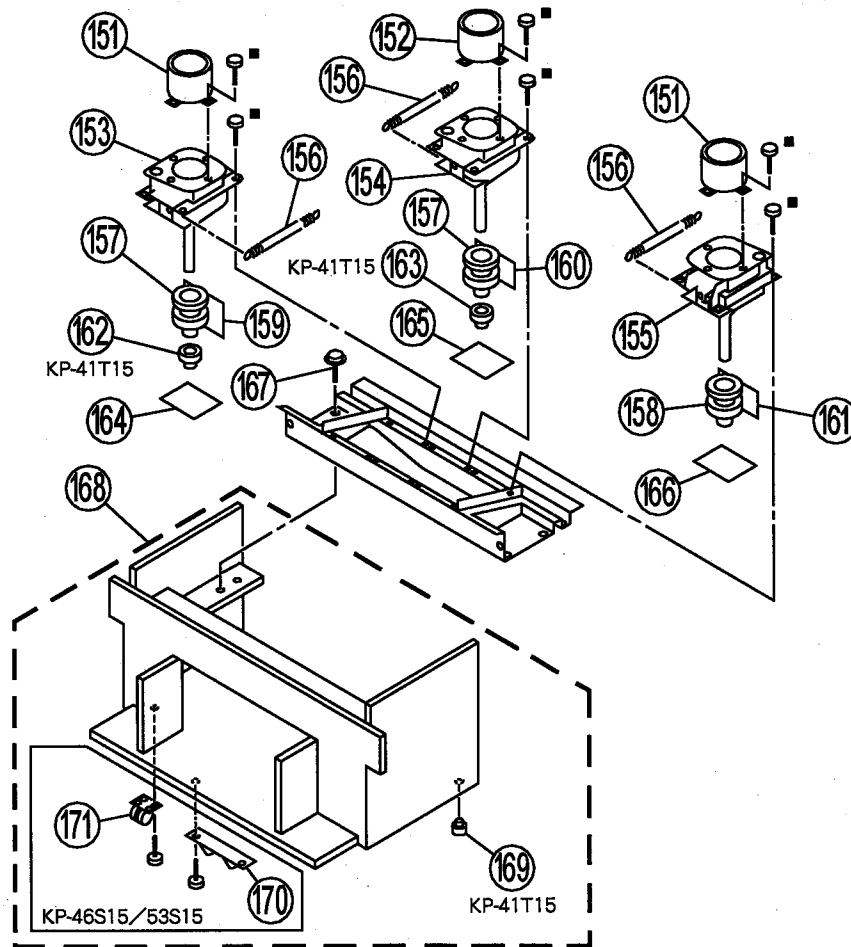

The components identified by shading and mark Δ are critical for safety. Replace only with part number specified.

Les composants identifiés par une trame et une marque Δ sont critiques pour la sécurité. Ne les remplacer que par une pièce portant le numéro spécifié.

REF.NO.	PART NO.	DESCRIPTION	REMARK	REF.NO.	PART NO.	DESCRIPTION	REMARK
151	4-034-057-01	LENS (LINNIT)		162	Δ 1-452-790-21	NECK ASSY. (KP-41T15)	
152	4-034-057-11	LENS (LINNIT)		163	Δ 1-452-790-11	NECK ASSY. (KP-41T15)	
153	Δ 8-736-080-05	PICTURE TUBE 07MAB5 (R) (KP-41T15/46S15)		164	*A-1331-408-A	CR BOARD, COMPLETE	
	Δ 8-736-082-05	PICTURE TUBE 07MAB6 (R) (KP-53S15)		165	*A-1331-409-A	CG BOARD, COMPLETE	
154	Δ 8-736-078-05	PICTURE TUBE 07MAB5 (G)		166	*A-1331-410-A	CB BOARD, COMPLETE	
155	Δ 8-736-079-05	PICTURE TUBE 07MAB5 (B) (KP-41T15/46S15)		167	4-041-164-11	SCREW (4X20), TAPPING	
	Δ 8-736-081-05	PICTURE TUBE 07MAB6 (B) (KP-53S15)		168	*X-4032-547-1	CABINET ASSY, BOTTOM (KP-41T15)	169
156	4-048-142-01	SPRING, TENSION			*X-4032-615-1	CABINET ASSY, BOTTOM (KP-46S15)	120, 121
157	Δ 8-451-463-11	DY Y829PA2N (R) (G)			*X-4032-616-1	CABINET ASSY, BOTTOM (KP-53T15)	120, 121
158	Δ 8-451-463-21	DY Y829PA2N2 (B)		169	4-047-987-01	FOOT (KP-41T15)	
159	*A-1390-487-A	ZR BOARD, COMPLETE (KP-41T15)		170	4-048-175-01	FOOT, PLASTIC (KP46S15/53S15)	
	*A-1390-513-A	ZR BOARD, COMPLETE (KP-46S15/53S15)		171	4-040-755-01	CASTER (DIA.30) (KP46S15/53S15)	
160	*A-1390-489-A	ZG BOARD, COMPLETE (KP-41T15)					
	*A-1390-512-A	ZG BOARD, COMPLETE (KP-46S15/53S15)					
161	*A-1390-491-A	ZB BOARD, COMPLETE					



SECTION 6
ELECTRICAL PARTS LIST

NOTE :

The components identified by shading and mark Δ are critical for safety. Replace only with part number specified.

Les composants identifiés par une trame et une marque Δ sont critiques pour la sécurité. Ne les remplacer que par une pièce portant le numéro spécifié.

• Items marked "*" are not stocked since they are seldom required for routine service. Some delay should be anticipated when ordering these items.

• All variable and adjustable resistors have characteristic curve B, unless otherwise noted.

RESISTORS

- All resistors are in ohms.
- F : nonflammable

When indicating parts by reference number, please include the board name.

CAPACITORS

COILS

- MF : μ F, PF : μ PF
- MMH : mH, UH : μ H

• The components identified by \square in this manual have been carefully factory-selected for each set in order to satisfy regulations regarding X-ray radiation. Should replacement be required, replace only with the value originally used.

REF.NO.	PART NO.	DESCRIPTION	REMARK	REF.NO.	PART NO.	DESCRIPTION	REMARK
*A-1195-062-A	P BOARD, COMPLETE	*****		C3249	1-163-117-00	CERAMIC CHIP 100PF	5% 50V
	<CAPACITOR>			C3250	1-163-113-00	CERAMIC CHIP 68PF	5% 50V
C3201	1-104-664-11	ELECT 47MF	20% 16V	C3251	1-164-232-11	CERAMIC CHIP 0.01MF	10% 50V
C3203	1-164-004-11	CERAMIC CHIP 0.1MF	10% 25V	C3252	1-163-103-00	CERAMIC CHIP 27PF	5% 50V
C3204	1-126-964-11	ELECT 10MF	20% 50V	C3253	1-163-101-00	CERAMIC CHIP 22PF	5% 50V
C3205	1-126-964-11	ELECT 10MF	20% 50V	C3254	1-163-141-00	CERAMIC CHIP 0.001MF	5% 50V
C3206	1-126-964-11	ELECT 10MF	20% 50V	C3255	1-163-101-00	CERAMIC CHIP 22PF	5% 50V
C3207	1-163-117-00	CERAMIC CHIP 100PF	5% 50V	C3256	1-164-232-11	CERAMIC CHIP 0.01MF	10% 50V
C3208	1-163-117-00	CERAMIC CHIP 100PF	5% 50V	C3257	1-163-117-00	CERAMIC CHIP 100PF	5% 50V
C3209	1-126-962-11	ELECT 3.3MF	20% 50V	C3258	1-163-113-00	CERAMIC CHIP 68PF	5% 50V
C3210	1-104-664-11	ELECT 47MF	20% 16V	C3259	1-163-111-00	CERAMIC CHIP 56PF	5% 50V
C3212	1-126-962-11	ELECT 3.3MF	20% 50V	C3260	1-163-119-00	CERAMIC CHIP 120PF	5% 50V
C3213	1-164-346-11	CERAMIC CHIP 1MF	16V	C3261	1-163-141-00	CERAMIC CHIP 0.001MF	5% 50V
C3214	1-164-346-11	CERAMIC CHIP 1MF	16V	C3263	1-163-141-00	CERAMIC CHIP 0.001MF	5% 50V
C3215	1-164-346-11	CERAMIC CHIP 1MF	16V	C3264	1-165-319-11	CERAMIC CHIP 0.1MF	50V
C3216	1-164-005-11	CERAMIC CHIP 0.47MF	25V	C3265	1-163-141-00	CERAMIC CHIP 0.001MF	5% 50V
C3217	1-164-346-11	CERAMIC CHIP 1MF	16V	C3266	1-163-141-00	CERAMIC CHIP 0.001MF	5% 50V
C3218	1-164-346-11	CERAMIC CHIP 1MF	16V	C3267	1-163-141-00	CERAMIC CHIP 0.001MF	5% 50V
C3219	1-126-941-11	ELECT 470MF	20% 16V	C3268	1-163-141-00	CERAMIC CHIP 0.001MF	5% 50V
C3220	1-164-346-11	CERAMIC CHIP 1MF	16V	C3269	1-163-141-00	CERAMIC CHIP 0.001MF	5% 50V
C3221	1-164-346-11	CERAMIC CHIP 1MF	16V	C3270	1-165-319-11	CERAMIC CHIP 0.1MF	50V
C3222	1-164-336-11	CERAMIC CHIP 0.33MF	25V	C3271	1-165-319-11	CERAMIC CHIP 0.1MF	50V
C3223	1-164-336-11	CERAMIC CHIP 0.33MF	25V	C3272	1-165-319-11	CERAMIC CHIP 0.1MF	50V
C3224	1-164-222-11	CERAMIC CHIP 0.22MF	25V	C3273	1-163-109-00	CERAMIC CHIP 47PF	5% 50V
C3225	1-164-222-11	CERAMIC CHIP 0.22MF	25V	C3274	1-163-101-00	CERAMIC CHIP 22PF	5% 50V
C3226	1-164-005-11	CERAMIC CHIP 0.47MF	25V	C3275	1-163-101-00	CERAMIC CHIP 22PF	5% 50V
C3227	1-164-346-11	CERAMIC CHIP 1MF	16V	C3276	1-163-111-00	CERAMIC CHIP 56PF	5% 50V
C3228	1-163-117-00	CERAMIC CHIP 100PF	5% 50V	C3277	1-163-101-00	CERAMIC CHIP 22PF	5% 50V
C3229	1-163-093-00	CERAMIC CHIP 10PF	5% 50V	C3278	1-163-101-00	CERAMIC CHIP 22PF	5% 50V
C3230	1-163-141-00	CERAMIC CHIP 0.001MF	5% 50V	C3279	1-163-141-00	CERAMIC CHIP 0.001MF	5% 50V
C3231	1-163-125-00	CERAMIC CHIP 220PF	5% 50V	C3280	1-126-964-11	ELECT 10MF	20% 50V
C3232	1-163-117-00	CERAMIC CHIP 100PF	5% 50V	C3282	1-164-346-11	CERAMIC CHIP 1MF	16V
C3233	1-164-232-11	CERAMIC CHIP 0.01MF	10% 50V		<CONNECTOR>		
C3234	1-164-232-11	CERAMIC CHIP 0.01MF	10% 50V	CN150	1-573-297-21	CONNECTOR, BOARD TO BOARD 18P	
C3235	1-164-232-11	CERAMIC CHIP 0.01MF	10% 50V		<DIODE>		
C3236	1-164-232-11	CERAMIC CHIP 0.01MF	10% 50V	D3202	8-719-031-68	DIODE HVU359TRF	
C3237	1-164-232-11	CERAMIC CHIP 0.01MF	10% 50V	D3203	8-719-404-46	DIODE MA110	
C3238	1-163-101-00	CERAMIC CHIP 22PF	5% 50V	D3208	8-719-110-17	DIODE RD10SEB2	
C3239	1-163-141-00	CERAMIC CHIP 0.001MF	5% 50V	D3209	8-719-110-17	DIODE RD10SEB2	
C3240	1-163-101-00	CERAMIC CHIP 22PF	5% 50V		<IC>		
C3241	1-163-103-00	CERAMIC CHIP 27PF	5% 50V	IC3200	8-759-288-13	IC MSW51C262-ZS	
C3242	1-164-232-11	CERAMIC CHIP 0.01MF	10% 50V	IC3201	8-759-093-29	IC MB86144BPF-G-BND	
C3243	1-163-117-00	CERAMIC CHIP 100PF	5% 50V	IC3202	8-759-093-28	IC MB40176PF-G-BND-EF	
C3244	1-163-113-00	CERAMIC CHIP 68PF	5% 50V	IC3203	8-759-093-28	IC MB40176PF-G-BND-EF	
C3245	1-164-232-11	CERAMIC CHIP 0.01MF	10% 50V	IC3204	8-759-093-25	IC MB3512PFQ	
C3246	1-164-232-11	CERAMIC CHIP 0.01MF	10% 50V				
C3247	1-163-033-91	CERAMIC CHIP 0.022MF	50V				
C3248	1-163-125-00	CERAMIC CHIP 220PF	5% 50V				



REF. NO.	PART NO.	DESCRIPTION	REMARK
IC3205	8-759-243-19	IC TC7SU04F	
<COIL>			
L3201	1-410-470-11	INDUCTOR 10UH	
L3202	1-408-424-00	INDUCTOR 180UH	
L3203	1-408-424-00	INDUCTOR 180UH	
L3204	1-410-476-11	INDUCTOR 33UH	
L3205	1-410-470-11	INDUCTOR 10UH	
L3206	1-410-387-11	INDUCTOR 33UH	
L3207	1-410-387-11	INDUCTOR 33UH	
L3208	1-410-387-11	INDUCTOR 33UH	
L3209	1-410-387-11	INDUCTOR 33UH	
<TRANSISTOR>			
Q3201	8-729-216-22	TRANSISTOR 2SA1162-G	
Q3202	8-729-422-27	TRANSISTOR 2SD601A-Q	
Q3203	8-729-216-22	TRANSISTOR 2SA1162-G	
Q3204	8-729-216-22	TRANSISTOR 2SA1162-G	
Q3206	8-729-422-27	TRANSISTOR 2SD601A-Q	
Q3207	8-729-216-22	TRANSISTOR 2SA1162-G	
Q3208	8-729-422-27	TRANSISTOR 2SD601A-Q	
Q3209	8-729-216-22	TRANSISTOR 2SA1162-G	
Q3210	8-729-216-22	TRANSISTOR 2SA1162-G	
<RESISTOR>			
R3201	1-216-097-00	METAL GLAZE 100K 5%	1/10W
R3202	1-216-073-00	METAL GLAZE 10K 5%	1/10W
R3203	1-216-025-00	METAL GLAZE 100 5%	1/10W
R3204	1-216-025-00	METAL GLAZE 100 5%	1/10W
R3205	1-216-121-00	METAL GLAZE 1M 5%	1/10W
R3207	1-216-295-00	CONDUCTOR, CHIP	
R3208	1-216-097-00	METAL GLAZE 100K 5%	1/10W
R3209	1-216-079-00	METAL GLAZE 18K 5%	1/10W
R3210	1-216-089-00	METAL GLAZE 47K 5%	1/10W
R3211	1-216-073-00	METAL GLAZE 10K 5%	1/10W
R3212	1-216-073-00	METAL GLAZE 10K 5%	1/10W
R3213	1-216-075-00	METAL GLAZE 12K 5%	1/10W
R3214	1-216-121-00	METAL GLAZE 1M 5%	1/10W
R3215	1-216-057-00	METAL GLAZE 2.2K 5%	1/10W
R3216	1-216-057-00	METAL GLAZE 2.2K 5%	1/10W
R3217	1-216-057-00	METAL GLAZE 2.2K 5%	1/10W
R3218	1-216-049-00	METAL GLAZE 1K 5%	1/10W
R3219	1-216-049-00	METAL GLAZE 1K 5%	1/10W
R3220	1-216-049-00	METAL GLAZE 1K 5%	1/10W
R3221	1-216-655-11	METAL CHIP 1.5K 0.50%	1/10W
R3222	1-216-655-11	METAL CHIP 1.5K 0.50%	1/10W
R3223	1-216-025-00	METAL GLAZE 100 5%	1/10W
R3224	1-216-049-00	METAL GLAZE 1K 5%	1/10W
R3225	1-216-025-00	METAL GLAZE 100 5%	1/10W
R3226	1-216-085-00	METAL GLAZE 33K 5%	1/10W
R3227	1-216-647-11	METAL CHIP 680 0.50%	1/10W
R3228	1-216-045-00	METAL GLAZE 680 5%	1/10W
R3229	1-216-073-00	METAL GLAZE 10K 5%	1/10W
R3230	1-216-073-00	METAL GLAZE 10K 5%	1/10W
R3231	1-216-001-00	METAL GLAZE 10 5%	1/10W
R3232	1-216-083-00	METAL GLAZE 27K 5%	1/10W
R3233	1-216-049-00	METAL GLAZE 1K 5%	1/10W
R3234	1-216-651-11	METAL CHIP 1K 0.50%	1/10W
R3235	1-216-043-91	METAL GLAZE 560 5%	1/10W
R3236	1-216-065-00	METAL GLAZE 4.7K 5%	1/10W
R3237	1-216-043-91	METAL GLAZE 560 5%	1/10W

REF. NO.	PART NO.	DESCRIPTION	REMARK
R3238	1-216-049-00	METAL GLAZE 1K 5%	1/10W
R3239	1-216-043-91	METAL GLAZE 560 5%	1/10W
R3241	1-216-057-00	METAL GLAZE 2.2K 5%	1/10W
R3242	1-216-049-00	METAL GLAZE 1K 5%	1/10W
R3243	1-216-025-00	METAL GLAZE 100 5%	1/10W
R3244	1-216-025-00	METAL GLAZE 100 5%	1/10W
R3245	1-216-025-00	METAL GLAZE 100 5%	1/10W
R3246	1-216-069-00	METAL GLAZE 6.8K 5%	1/10W
R3247	1-216-063-00	METAL GLAZE 3.9K 5%	1/10W
R3248	1-216-295-00	CONDUCTOR, CHIP	
R3249	1-216-057-00	METAL GLAZE 2.2K 5%	1/10W
R3250	1-216-043-91	METAL GLAZE 560 5%	1/10W
R3251	1-216-049-00	METAL GLAZE 1K 5%	1/10W
R3252	1-216-043-91	METAL GLAZE 560 5%	1/10W
R3253	1-216-065-00	METAL GLAZE 4.7K 5%	1/10W
R3254	1-216-043-91	METAL GLAZE 560 5%	1/10W
R3255	1-216-041-00	METAL GLAZE 470 5%	1/10W
R3256	1-216-043-91	METAL GLAZE 560 5%	1/10W
R3259	1-216-298-00	METAL GLAZE 2.2 5%	1/10W
R3260	1-216-073-00	METAL GLAZE 10K 5%	1/10W
R3263	1-216-025-00	METAL GLAZE 100 5%	1/10W
R3264	1-216-025-00	METAL GLAZE 100 5%	1/10W
R3265	1-216-049-00	METAL GLAZE 1K 5%	1/10W
R3266	1-216-057-00	METAL GLAZE 2.2K 5%	1/10W
R3267	1-216-055-00	METAL GLAZE 1.8K 5%	1/10W
R3268	1-216-053-00	METAL GLAZE 1.5K 5%	1/10W
R3269	1-216-057-00	METAL GLAZE 2.2K 5%	1/10W
R3270	1-216-657-11	METAL CHIP 1.8K 0.50%	1/10W
R3271	1-216-655-11	METAL CHIP 1.5K 0.50%	1/10W
R3273	1-216-073-00	METAL GLAZE 10K 5%	1/10W
R3274	1-216-049-00	METAL GLAZE 1K 5%	1/10W
R3275	1-216-049-00	METAL GLAZE 1K 5%	1/10W
R3276	1-216-049-00	METAL GLAZE 1K 5%	1/10W
R3277	1-216-298-00	METAL GLAZE 2.2 5%	1/10W
<CRYSTAL>			
X3201	1-567-878-11	VIBRATOR, CRYSTAL	
X3202	1-567-878-11	VIBRATOR, CRYSTAL	

*A-1297-476-A A BOARD, COMPLETE			

4-365-216-00 SPACER, MICA			
4-382-854-11 SCREW (M3X10), P, SW (+)			
<CAPACITOR>			
C201	1-104-665-11	ELECT 100MF	20% 25V
C202	1-102-125-00	CERAMIC 0.0047MF	10% 50V
C203	1-130-489-00	FILM 0.033MF	5% 50V
C204	1-124-902-00	ELECT 0.47MF	20% 50V
C205	1-104-665-11	ELECT 100MF	20% 25V
C206	1-124-902-00	ELECT 0.47MF	20% 50V
C207	1-124-903-11	ELECT 1MF	20% 50V
C208	1-124-768-11	ELECT 4.7MF	20% 50V
C209	1-124-903-11	ELECT 1MF	20% 50V
C210	1-102-125-00	CERAMIC 0.0047MF	10% 50V
C211	1-130-489-00	FILM 0.033MF	5% 50V
C212	1-124-768-11	ELECT 4.7MF	20% 50V
C220	1-126-964-11	ELECT 10MF	20% 50V
C221	1-126-964-11	ELECT 10MF	20% 50V
C222	1-126-964-11	ELECT 10MF	20% 50V



REF. NO.	PART NO.	DESCRIPTION	REMARK	REF. NO.	PART NO.	DESCRIPTION	REMARK
C223	1-126-964-11	ELECT	10MF 20%	50V			
C226	1-104-665-11	ELECT	100MF 20%	25V	D201	8-719-110-17	DIODE RD10ESB2
C232	1-104-664-11	ELECT	47MF 20%	25V	D202	8-719-110-17	DIODE RD10ESB2
C233	1-124-903-11	ELECT	1MF 20%	50V	D220	8-719-911-19	DIODE ISS119-25
C234	1-104-664-11	ELECT	47MF 20%	25V	D221	8-719-911-19	DIODE ISS119-25
					D231	8-719-911-19	DIODE ISS119-25
C236	1-124-902-00	ELECT	0.47MF 20%	50V	D232	8-719-911-19	DIODE ISS119-25
C238	1-104-665-11	ELECT	100MF 20%	25V	D262	8-719-911-19	DIODE ISS119-25
C239	1-126-943-11	ELECT	2200MF 20%	25V	D263	8-719-911-19	DIODE ISS119-25
C240	1-126-943-11	ELECT	2200MF 20%	25V	D264	8-719-911-19	DIODE ISS119-25
C241	1-137-399-11	FILM	0.1MF 5%	50V	D301	8-719-110-56	DIODE RD22ESB1
C242	1-137-399-11	FILM	0.1MF 5%	50V	D302	8-719-110-56	DIODE RD22ESB1
C243	1-137-399-11	FILM	0.1MF 5%	50V	D303	8-719-110-56	DIODE RD22ESB1
C244	1-104-665-11	ELECT	100MF 20%	25V	D304	8-719-110-56	DIODE RD22ESB1
C245	1-137-399-11	FILM	0.1MF 5%	50V	D501	8-719-911-19	DIODE ISS119-25
C262	1-104-664-11	ELECT	47MF 20%	25V	D502	8-719-109-72	DIODE RD3.9ESB2
C263	1-104-665-11	ELECT	100MF 20%	25V	D504	8-719-911-19	DIODE ISS119-25
C264	1-104-665-11	ELECT	100MF 20%	25V	D505	8-719-911-19	DIODE ISS119-25
C265	1-104-665-11	ELECT	100MF 20%	25V	D506	8-719-300-80	DIODE RU-1C
C266	1-104-665-11	ELECT	100MF 20%	25V	D507	8-719-018-82	DIODE RGPO2-20EL-6394
C267	1-104-664-11	ELECT	47MF 20%	25V	D509	8-719-900-95	DIODE V09G
C501	1-124-902-00	ELECT	0.47MF 20%	50V	D510	8-719-900-95	DIODE V09G
C502	1-104-664-11	ELECT	47MF 20%	25V	D511	8-719-911-19	DIODE ISS119-25
C503	1-137-370-11	FILM	0.01MF 5%	50V	D1001	8-719-110-76	DIODE RD33ESB1
C504	1-164-070-11	CERAMIC	100PF 5%	50V			
C505	1-137-372-11	FILM	0.022MF 5%	50V			
C506	1-123-024-21	ELECT	33MF	160V			<IC>
C507	1-107-368-11	FILM	0.047MF 10%	200V	IC201	8-759-135-80	IC UPC358C
C508	1-107-638-11	ELECT	33MF 20%	160V	IC202	8-759-090-21	IC TDA8424
C509	1-107-368-11	FILM	0.047MF 10%	200V	IC230	8-759-190-89	IC TPA7265
C510	1-102-030-00	CERAMIC	330PF 10%	500V	IC262	8-759-054-12	IC PQ09RA1
C511	1-137-414-11	FILM	0.0047MF 10%	100V	IC263	8-759-504-46	IC PQ05RF1
C512	1-162-115-00	CERAMIC	330PF 10%	2KV	IC264	8-759-701-79	IC NJM7812FA
C513	1-136-598-11	FILM	3MF 5%	200V			
C514	1-136-613-11	FILM	0.0068MF 3%	2KV			
C515	1-162-114-00	CERAMIC	0.0047MF	2KV			
C516	1-107-719-11	ELECT	220MF 20%	50V			<COIL>
C517	1-126-971-11	ELECT	470MF 20%	50V	L501	1-411-189-11	COIL, CHOKE 15MMH
C518	1-126-971-11	ELECT	470MF 20%	50V	L503	1-406-832-11	COIL, HORIZONTAL LINEARITY(HLC)
C519	1-124-903-11	ELECT	1MF 20%	50V	L1001	1-408-408-00	INDUCTOR 8.2UH
C1001	1-124-927-11	ELECT	4.7MF 20%	50V	L1002	1-408-408-00	INDUCTOR 8.2UH
C1004	1-126-935-11	ELECT	470MF 20%	16V	L1003	1-408-408-00	INDUCTOR 8.2UH
C1005	1-104-665-11	ELECT	100MF 20%	25V			<TRANSISTOR>
C1006	1-101-004-00	CERAMIC	0.01MF	50V	Q220	8-729-927-14	TRANSISTOR DTC323TS
C1007	1-126-935-11	ELECT	470MF 20%	16V	Q221	8-729-119-76	TRANSISTOR 2SA1175-HFE
C1008	1-101-004-00	CERAMIC	0.01MF	50V	Q222	8-729-927-14	TRANSISTOR DTC323TS
C1010	1-126-964-11	ELECT	10MF 20%	50V	Q223	8-729-119-76	TRANSISTOR 2SA1175-HFE
C1012	1-102-121-00	CERAMIC	0.0022MF 10%	50V	Q230	8-729-119-78	TRANSISTOR 2SC2785-HFE
		<CONNECTOR>			Q231	8-729-119-78	TRANSISTOR 2SC2785-HFE
CN221	1-573-298-21	CONNECTOR, BOARD TO BOARD	20P		Q232	8-729-119-78	TRANSISTOR 2SC2785-HFE
CN222	1-573-298-21	CONNECTOR, BOARD TO BOARD	20P		Q234	8-729-119-78	TRANSISTOR 2SC2785-HFE
CN223	*1-564-507-11	PLUG, CONNECTOR	4P		Q235	8-729-119-76	TRANSISTOR 2SA1175-HFE
CN224	*1-564-507-11	PLUG, CONNECTOR	4P		Q236	8-729-119-78	TRANSISTOR 2SC2785-HFE
CN225	*1-564-513-11	PLUG, CONNECTOR	10P		Q501	8-729-119-76	TRANSISTOR 2SA1175-HFE
CN511	*1-580-689-11	PIN, CONNECTOR (PC BOARD)	4P		Q502	8-729-119-76	TRANSISTOR 2SA1175-HFE
CN527	*1-573-963-11	PIN, CONNECTOR (PC BOARD)	3P		Q503	8-729-119-78	TRANSISTOR 2SC2785-HFE
CN528	1-695-915-11	TAB (CONTACT)			Q504	8-729-119-78	TRANSISTOR 2SC2785-HFE
CN541	*1-580-689-11	PIN, CONNECTOR (PC BOARD)	4P		Q505	8-729-119-80	TRANSISTOR 2SC2688-LK
CN571	*1-580-689-11	PIN, CONNECTOR (PC BOARD)	4P		Q506	8-729-201-31	TRANSISTOR 2SA1013-0
CN1026	*1-564-506-11	PLUG, CONNECTOR	3P		Q507	8-729-304-92	TRANSISTOR 2SB649A-C
		<DIODE>			Q508	8-729-201-31	TRANSISTOR 2SA1013-0
					Q509	8-729-010-98	TRANSISTOR 2SA1492M-OPY
					Q510	8-729-021-48	TRANSISTOR 2SD2348 LBSONY

The components identified by shading and mark Δ are critical for safety. Replace only with part number specified.

Les composants identifiés par une trame et une marque Δ sont critiques pour la sécurité. Ne les remplacer que par une pièce portant le numéro spécifié.



REF.NO.	PART NO.	DESCRIPTION	REMARK
Q511	8-729-119-76	TRANSISTOR 2SA1175-HFE	
Q1003	8-729-119-76	TRANSISTOR 2SA1175-HFE	
Q1004	8-729-119-78	TRANSISTOR 2SC2785-HFE	
<RESISTOR>			
R201	1-249-429-11	CARBON 10K 5% 1/4W	
R203	1-249-429-11	CARBON 10K 5% 1/4W	
R204	1-249-429-11	CARBON 10K 5% 1/4W	
R205	1-249-429-11	CARBON 10K 5% 1/4W	
R207	1-249-431-11	CARBON 15K 5% 1/4W	
R208	1-249-429-11	CARBON 10K 5% 1/4W	
R209	1-249-431-11	CARBON 15K 5% 1/4W	
R210	1-247-815-91	CARBON 220 5% 1/4W	
R211	1-249-429-11	CARBON 10K 5% 1/4W	
R212	1-249-441-11	CARBON 100K 5% 1/4W	
R213	1-249-441-11	CARBON 100K 5% 1/4W	
R214	1-247-815-91	CARBON 220 5% 1/4W	
R215	1-249-441-11	CARBON 100K 5% 1/4W	
R216	1-249-441-11	CARBON 100K 5% 1/4W	
R217	1-247-807-31	CARBON 100 5% 1/4W	
R218	1-247-807-31	CARBON 100 5% 1/4W	
R219	1-249-417-11	CARBON 1K 5% 1/4W	
R220	1-249-429-11	CARBON 10K 5% 1/4W	
R221	1-249-437-11	CARBON 47K 5% 1/4W	
R222	1-249-417-11	CARBON 1K 5% 1/4W	
R223	1-249-429-11	CARBON 10K 5% 1/4W	
R224	1-249-429-11	CARBON 10K 5% 1/4W	
R230	1-249-430-11	CARBON 12K 5% 1/4W	
R231	1-249-429-11	CARBON 10K 5% 1/4W	
R233	1-249-429-11	CARBON 10K 5% 1/4W	
R234	1-249-441-11	CARBON 100K 5% 1/4W	
R235	1-249-414-11	CARBON 560 5% 1/4W	
R236	1-249-432-11	CARBON 18K 5% 1/4W	
R237	1-249-414-11	CARBON 560 5% 1/4W	
R238	1-249-431-11	CARBON 15K 5% 1/4W	
R239	1-249-430-11	CARBON 12K 5% 1/4W	
R241	1-249-436-11	CARBON 39K 5% 1/4W	
R242	1-249-432-11	CARBON 18K 5% 1/4W	
R243	1-247-863-91	CARBON 22K 5% 1/4W	
R244	1-247-863-91	CARBON 22K 5% 1/4W	
R246	1-247-863-91	CARBON 22K 5% 1/4W	
R247	1-249-430-11	CARBON 12K 5% 1/4W	
R249	1-247-807-31	CARBON 100 5% 1/4W	
R250	1-249-417-11	CARBON 1K 5% 1/4W	
R251	1-249-437-11	CARBON 47K 5% 1/4W	
R252	1-249-417-11	CARBON 1K 5% 1/4W	
R255	1-249-429-11	CARBON 10K 5% 1/4W	
R257	1-249-429-11	CARBON 10K 5% 1/4W	
R258	1-249-429-11	CARBON 10K 5% 1/4W	
R259	1-216-357-00	METAL OXIDE 4.7 5% 1W F	
R260	1-216-357-00	METAL OXIDE 4.7 5% 1W F	
R501	1-249-421-11	CARBON 2.2K 5% 1/4W	
R502	1-249-429-11	CARBON 10K 5% 1/4W	
R503	1-249-441-11	CARBON 100K 5% 1/4W	
R504	1-249-429-11	CARBON 10K 5% 1/4W	
R505	1-215-437-00	METAL 4.7K 1% 1/4W	
R506	1-215-433-00	METAL 3.3K 1% 1/4W	
R507	1-249-407-11	CARBON 150 5% 1/4W	
R508	1-249-421-11	CARBON 2.2K 5% 1/4W	
R509	1-249-423-11	CARBON 3.3K 5% 1/4W	
R510	1-249-417-11	CARBON 1K 5% 1/4W	
R511	1-247-895-00	CARBON 470K 5% 1/4W	
R512	1-215-925-11	METAL OXIDE 22K 5% 3W F	

REF.NO.	PART NO.	DESCRIPTION	REMARK
R513	1-215-900-11	METAL OXIDE 22K 5% 2W F	
R514	1-249-421-11	CARBON 2.2K 5% 1/4W F	
R515	1-215-925-11	METAL OXIDE 22K 5% 3W F	
R516	1-249-430-11	CARBON 12K 5% 1/4W F	
R517	1-249-429-11	CARBON 10K 5% 1/4W	
R518	1-249-427-11	CARBON 6.8K 5% 1/4W F	
R519	1-249-417-11	CARBON 1K 5% 1/4W	
R520	1-249-423-11	CARBON 3.3K 5% 1/4W F	
R521	1-249-437-11	CARBON 47K 5% 1/4W	
R522	1-249-417-11	CARBON 1K 5% 1/4W F	
R523	1-249-426-11	CARBON 5.6K 5% 1/4W F	
R524	1-215-925-11	METAL OXIDE 22K 5% 3W F	
R525	1-216-373-11	METAL OXIDE 2.2 5% 2W F	
R526	1-216-478-11	METAL OXIDE 390 5% 3W F	
R528	1-216-477-11	METAL OXIDE 270 5% 3W F	
R529	1-216-477-11	METAL OXIDE 270 5% 3W F	
R530	1-216-477-11	METAL OXIDE 270 5% 3W F	
R531	1-216-477-11	METAL OXIDE 270 5% 3W F	
R532	1-215-442-00	METAL 7.5K 1% 1/4W	
R533	1-215-443-00	METAL 8.2K 1% 1/4W	
R534	1-215-437-00	METAL 4.7K 1% 1/4W	
R1001	1-215-900-11	METAL OXIDE 22K 5% 2W F	
R1006	1-249-434-11	CARBON 27K 5% 1/4W	
R1007	1-249-425-11	CARBON 4.7K 5% 1/4W	
R1008	1-247-807-31	CARBON 100 5% 1/4W	
R1010	1-249-411-11	CARBON 330 5% 1/4W	
R1014	1-249-436-11	CARBON 39K 5% 1/4W	
R1016	1-247-807-31	CARBON 100 5% 1/4W	
R1017	1-249-417-11	CARBON 1K 5% 1/4W	
R1018	1-215-432-00	METAL 3K 1% 1/4W	
R1019	1-249-441-11	CARBON 100K 5% 1/4W	
<TRANSFORMER>			
T501 A 1-437-078-11 TRANSFORMER, HORIZONTAL DRIVE			
<TUNER>			
TUL002A 8-598-254-00 TUNER BTR WA402			

	*A-1306-493-A	M BOARD, COMPLETE (KP-41T15)	
	*A-1306-498-A	M BOARD, COMPLETE (KP-46S15/53S15)	
	4-382-854-11	SCREW (M3X10), P, SW (+)	
<CAPACITOR>			
C001	1-126-935-11	ELECT 470MF 20% 16V	
C002	1-126-916-11	ELECT 1000MF 20% 6.3V	
C004	1-163-001-11	CERAMIC CHIP 220PF 10% 50V	
C005	1-163-001-11	CERAMIC CHIP 220PF 10% 50V	
C006	1-163-001-11	CERAMIC CHIP 220PF 10% 50V	
C007	1-163-001-11	CERAMIC CHIP 220PF 10% 50V	
C009	1-163-001-11	CERAMIC CHIP 220PF 10% 50V	
C010	1-163-001-11	CERAMIC CHIP 220PF 10% 50V	
C011	1-163-001-11	CERAMIC CHIP 220PF 10% 50V	
C012	1-163-001-11	CERAMIC CHIP 220PF 10% 50V	
C013	1-163-001-11	CERAMIC CHIP 220PF 10% 50V	
C014	1-163-001-11	CERAMIC CHIP 220PF 10% 50V	
C015	1-163-001-11	CERAMIC CHIP 220PF 10% 50V	



REF. NO.	PART NO.	DESCRIPTION	REMARK	REF. NO.	PART NO.	DESCRIPTION	REMARK
C016	1-163-001-11	CERAMIC CHIP 220PF	10% 50V	C323	1-163-031-11	CERAMIC CHIP 0.01MF	50V
C017	1-163-001-11	CERAMIC CHIP 220PF	10% 50V	C324	1-128-551-11	ELECT 22MF	20% 50V
C018	1-163-001-11	CERAMIC CHIP 220PF	10% 50V	C327	1-163-139-00	CERAMIC CHIP 820PF	5% 50V
C019	1-163-001-11	CERAMIC CHIP 220PF	10% 50V	C328	1-163-117-00	CERAMIC CHIP 100PF	5% 50V
C020	1-163-001-11	CERAMIC CHIP 220PF	10% 50V	C329	1-163-001-11	CERAMIC CHIP 220PF	10% 50V
C021	1-163-001-11	CERAMIC CHIP 220PF	10% 50V	C338	1-124-927-11	ELECT 4.7MF	20% 50V
C022	1-163-001-11	CERAMIC CHIP 220PF	10% 50V	C339	1-124-464-11	ELECT 0.22MF	20% 50V
C023	1-163-001-11	CERAMIC CHIP 220PF	10% 50V	C340	1-163-133-00	CERAMIC CHIP 470PF	5% 50V
C024	1-163-001-11	CERAMIC CHIP 220PF	10% 50V	C341	1-124-902-00	ELECT 0.47MF	20% 50V
C025	1-163-001-11	CERAMIC CHIP 220PF	10% 50V	C342	1-124-902-00	ELECT 0.47MF	20% 50V
C026	1-163-001-11	CERAMIC CHIP 220PF	10% 50V	C343	1-124-902-00	ELECT 0.47MF	20% 50V
C028	1-163-001-11	CERAMIC CHIP 220PF	10% 50V	C344	1-163-031-11	CERAMIC CHIP 0.01MF	50V
C029	1-163-001-11	CERAMIC CHIP 220PF	10% 50V	C345	1-163-031-11	CERAMIC CHIP 0.01MF	50V
C030	1-163-001-11	CERAMIC CHIP 220PF	10% 50V	C346	1-163-031-11	CERAMIC CHIP 0.01MF	50V
C031	1-163-001-11	CERAMIC CHIP 220PF	10% 50V	C347	1-124-902-00	ELECT 0.47MF	20% 50V
C032	1-163-001-11	CERAMIC CHIP 220PF	10% 50V	C348	1-163-097-00	CERAMIC CHIP 15PF	5% 50V
C033	1-163-809-11	CERAMIC CHIP 0.047MF	10% 25V	C349	1-163-109-00	CERAMIC CHIP 47PF	5% 50V
C034	1-163-001-11	CERAMIC CHIP 220PF	10% 50V	C350	1-126-964-11	ELECT 10MF	20% 50V
C035	1-124-903-11	ELECT 1MF	20% 50V				(KP-41T15)
C037	1-163-009-11	CERAMIC CHIP 0.001MF	10% 50V	C352	1-163-031-11	CERAMIC CHIP 0.01MF	50V
C038	1-126-940-11	ELECT 330MF	20% 16V	C353	1-104-665-11	ELECT 100MF	20% 25V
C040	1-124-903-11	ELECT 1MF	20% 50V	C354	1-163-101-00	CERAMIC CHIP 22PF	5% 50V
C041	1-163-001-11	CERAMIC CHIP 220PF	10% 50V				(KP-41T15)
C042	1-163-001-11	CERAMIC CHIP 220PF	10% 50V	C355	1-128-551-11	ELECT 22MF	20% 50V
C046	1-163-125-00	CERAMIC CHIP 220PF	5% 50V				(KP-41T15)
C047	1-124-903-11	ELECT 1MF	20% 50V	C357	1-104-664-11	ELECT 47MF	20% 25V
C048	1-163-245-11	CERAMIC CHIP 56PF	5% 50V				(KP-41T15)
C049	1-163-001-11	CERAMIC CHIP 220PF	10% 50V	C358	1-163-097-00	CERAMIC CHIP 15PF	5% 50V
C050	1-163-031-11	CERAMIC CHIP 0.01MF	50V				(KP-41T15)
C051	1-163-017-00	CERAMIC CHIP 0.0047MF	10% 50V	C359	1-163-125-00	CERAMIC CHIP 220PF	5% 50V
C054	1-163-001-11	CERAMIC CHIP 220PF	10% 50V				(KP-41T15)
C055	1-163-037-11	CERAMIC CHIP 0.022MF	10% 25V	C360	1-126-964-11	ELECT 10MF	20% 50V
C056	1-163-001-11	CERAMIC CHIP 220PF	10% 50V				(KP-41T15)
C057	1-163-159-00	CERAMIC CHIP 12PF	2% 50V	C361	1-126-964-11	ELECT 10MF	20% 50V
C058	1-104-896-11	CERAMIC CHIP 24PF	2% 50V				(KP-41T15)
C060	1-124-903-11	ELECT 1MF	20% 50V	C362	1-163-101-00	CERAMIC CHIP 22PF	5% 50V
C062	1-163-038-00	CERAMIC CHIP 0.1MF	25V				(KP-41T15)
C063	1-126-964-11	ELECT 10MF	20% 50V	C363	1-163-009-11	CERAMIC CHIP 0.001MF	10% 50V
C064	1-126-964-11	ELECT 10MF	20% 50V				(KP-41T15)
C065	1-163-038-00	CERAMIC CHIP 0.1MF	25V	C364	1-126-964-11	ELECT 10MF	20% 50V
C066	1-163-135-00	CERAMIC CHIP 560PF	5% 50V				(KP-41T15)
C067	1-137-399-11	FILM 0.1MF	5% 50V	C365	1-163-101-00	CERAMIC CHIP 22PF	5% 50V
C068	1-137-367-11	FILM 0.0033MF	5% 50V	C366	1-163-117-00	CERAMIC CHIP 100PF	5% 50V
C069	1-137-375-11	FILM 0.068MF	5% 50V	C368	1-163-093-00	CERAMIC CHIP 10PF	5% 50V
C070	1-104-664-11	ELECT 47MF	20% 25V	C369	1-163-809-11	CERAMIC CHIP 0.047MF	10% 25V
C071	1-124-464-11	ELECT 0.22MF	20% 50V	C370	1-104-665-11	ELECT 100MF	20% 25V
C074	1-126-940-11	ELECT 330MF	20% 16V	C371	1-104-665-11	ELECT 100MF	20% 25V
C075	1-163-031-11	CERAMIC CHIP 0.01MF	50V				<CONDUCTOR CHIP>
C302	1-124-902-00	ELECT 0.47MF	20% 50V	CJ001	1-216-295-00	CONDUCTOR, CHIP	
C303	1-124-902-00	ELECT 0.47MF	20% 50V	CJ002	1-216-295-00	CONDUCTOR, CHIP	
C304	1-124-927-11	ELECT 4.7MF	20% 50V	CJ003	1-216-295-00	CONDUCTOR, CHIP	
C309	1-163-019-00	CERAMIC CHIP 0.0068MF	10% 50V				<CONNECTOR>
C310	1-163-017-00	CERAMIC CHIP 0.0047MF	10% 50V	CN046	*1-564-512-11	PLUG, CONNECTOR 9P	
C311	1-124-925-11	ELECT 2.2MF	20% 50V	CN053	*1-564-507-11	PLUG, CONNECTOR 4P	
C312	1-163-017-00	CERAMIC CHIP 0.0047MF	10% 50V	CN054	1-573-979-21	CONNECTOR, BOARD TO BOARD 11P	
C313	1-104-664-11	ELECT 47MF	20% 25V	CN304	*1-564-512-11	PLUG, CONNECTOR 9P	
C314	1-163-031-11	CERAMIC CHIP 0.01MF	50V	CN314	*1-564-509-11	PLUG, CONNECTOR 6P	(KP-41T15)
C315	1-126-934-11	ELECT 220MF	20% 16V	CN321	1-573-301-21	CONNECTOR, BOARD TO BOARD 20P	
C316	1-131-374-00	TANTALUM 33MF	10% 16V	CN322	1-573-301-21	CONNECTOR, BOARD TO BOARD 20P	
C317	1-163-031-11	CERAMIC CHIP 0.01MF	50V				
C318	1-124-925-11	ELECT 2.2MF	20% 50V				
C319	1-124-903-11	ELECT 1MF	20% 50V				
C320	1-124-903-11	ELECT 1MF	20% 50V				
C321	1-163-017-00	CERAMIC CHIP 0.0047MF	10% 50V				



REF.NO.	PART NO.	DESCRIPTION	REMARK	REF.NO.	PART NO.	DESCRIPTION	REMARK
CN351	*1-564-509-11	PLUG, CONNECTOR 6P		L004	1-410-476-11	INDUCTOR 33UH	
CN355	*1-565-930-11	CONNECTOR (RECEPTACLE) 30P		L005	1-410-470-11	INDUCTOR 10UH	
CN356	*1-566-367-11	CONNECTOR, HINGE (RECEPTACLE)		L006	1-410-470-11	INDUCTOR 10UH	
CN357	*1-564-516-11	PLUG, CONNECTOR 13P		L302	1-408-413-00	INDUCTOR 22UH	(KP-41T15)
CN358	*1-564-508-11	PLUG, CONNECTOR 5P		L303	1-408-416-00	INDUCTOR 39UH	(KP-41T15)
				L304	1-410-468-11	INDUCTOR 6.8UH	
		<DIODE>				<TRANSISTOR>	
D001	8-719-404-46	DIODE MA110		Q001	8-729-216-22	TRANSISTOR 2SA1162-G	
D002	8-719-404-46	DIODE MA110		Q002	8-729-120-28	TRANSISTOR 2SC1623-L5L6	
D003	8-719-404-46	DIODE MA110		Q003	8-729-120-28	TRANSISTOR 2SC1623-L5L6	
D004	8-719-109-88	DIODE RD5.6ESB1		Q004	8-729-216-22	TRANSISTOR 2SA1162-G	
D005	8-719-109-88	DIODE RD5.6ESB1		Q005	8-729-120-28	TRANSISTOR 2SC1623-L5L6	
D006	8-719-109-88	DIODE RD5.6ESB1		Q006	8-729-120-28	TRANSISTOR 2SC1623-L5L6	
D007	8-719-109-88	DIODE RD5.6ESB1		Q007	8-729-216-22	TRANSISTOR 2SA1162-G	
D008	8-719-002-81	DIODE 1T363		Q008	8-729-216-22	TRANSISTOR 2SA1162-G	
D009	8-719-404-46	DIODE MA110		Q009	8-729-120-28	TRANSISTOR 2SC1623-L5L6	
D010	8-719-404-46	DIODE MA110		Q010	8-729-216-22	TRANSISTOR 2SA1162-G	
D011	8-719-404-46	DIODE MA110		Q011	8-729-216-22	TRANSISTOR 2SA1162-G	
D012	8-719-404-46	DIODE MA110		Q012	8-729-120-28	TRANSISTOR 2SC1623-L5L6	
D013	8-719-404-46	DIODE MA110		Q017	8-729-120-28	TRANSISTOR 2SC1623-L5L6	
D014	8-719-404-46	DIODE MA110		Q018	8-729-216-22	TRANSISTOR 2SA1162-G	
D015	8-719-404-46	DIODE MA110		Q019	8-729-120-28	TRANSISTOR 2SC1623-L5L6	
D016	8-719-404-46	DIODE MA110		Q301	8-729-216-22	TRANSISTOR 2SA1162-G	
D017	8-719-404-46	DIODE MA110		Q302	8-729-216-22	TRANSISTOR 2SA1162-G	
D018	8-719-404-46	DIODE MA110		Q303	8-729-216-22	TRANSISTOR 2SA1162-G	
D019	8-719-404-46	DIODE MA110		Q304	8-729-216-22	TRANSISTOR 2SA1162-G	
D020	8-719-105-91	DIODE RD5.6M-B2		Q305	8-729-120-28	TRANSISTOR 2SC1623-L5L6	
D305	8-719-121-24	DIODE RD9.1ESL		Q307	8-729-120-28	TRANSISTOR 2SC1623-L5L6	
D307	8-719-121-24	DIODE RD9.1ESL		Q308	8-729-216-22	TRANSISTOR 2SA1162-G	
D308	8-719-110-22	DIODE RD11ESB2		Q309	8-729-216-22	TRANSISTOR 2SA1162-G	
D309	8-719-109-84	DIODE RD5.1ESB1		Q310	8-729-120-28	TRANSISTOR 2SC1623-L5L6	(KP-41T15)
D310	8-719-914-44	DIODE DAP20K		Q311	8-729-120-28	TRANSISTOR 2SC1623-L5L6	
D311	8-719-914-43	DIODE DAN202K		Q312	8-729-120-28	TRANSISTOR 2SC1623-L5L6	(KP-41T15)
D312	8-719-404-46	DIODE MA110		Q313	8-729-120-28	TRANSISTOR 2SC1623-L5L6	
D313	8-719-404-46	DIODE MA110		Q314	8-729-120-28	TRANSISTOR 2SC1623-L5L6	(KP-41T15)
D314	8-719-404-46	DIODE MA110		Q315	8-729-120-28	TRANSISTOR 2SC1623-L5L6	(KP-41T15)
D315	8-719-109-88	DIODE RD5.6ESB1		Q316	8-729-120-28	TRANSISTOR 2SC1623-L5L6	(KP-41T15)
D316	8-719-404-46	DIODE MA110		Q317	8-729-216-22	TRANSISTOR 2SA1162-G	(KP-41T15)
D317	8-719-110-22	DIODE RD11ESB2		Q318	8-729-120-28	TRANSISTOR 2SC1623-L5L6	(KP-41T15)
D320	8-719-404-46	DIODE MA110	(KP-41T15)	Q319	8-729-120-28	TRANSISTOR 2SC1623-L5L6	(KP-41T15)
D321	8-719-404-46	DIODE MA110	(KP-41T15)	Q320	8-729-120-28	TRANSISTOR 2SC1623-L5L6	(KP-41T15)
D322	8-719-404-46	DIODE MA110	(KP-41T15)	Q321	8-729-120-28	TRANSISTOR 2SC1623-L5L6	(KP-41T15)
D323	8-719-404-46	DIODE MA110	(KP-41T15)	Q322	8-729-120-28	TRANSISTOR 2SC1623-L5L6	
D324	8-719-404-46	DIODE MA110	(KP-41T15)			<RESISTOR>	
D325	8-719-404-46	DIODE MA110	(KP-41T15)	R001	1-216-049-00	METAL GLAZE 1K 5%	1/10W
D326	8-719-110-08	DIODE RD8.2ESB2		R002	1-216-049-00	METAL GLAZE 1K 5%	1/10W
D327	8-719-404-46	DIODE MA110		R003	1-216-033-00	METAL GLAZE 220 5%	1/10W
D328	8-719-911-19	DIODE ISS119-25		R004	1-216-033-00	METAL GLAZE 220 5%	1/10W
		<IC>		R005	1-216-033-00	METAL GLAZE 220 5%	1/10W
IC001	8-759-112-06	IC UPC78N05H		R006	1-216-033-00	METAL GLAZE 220 5%	1/10W
IC002	8-752-863-20	IC CXP85332A-033S		R007	1-216-033-00	METAL GLAZE 220 5%	1/10W
IC003	8-759-284-16	IC ST24C04CB1		R008	1-216-033-00	METAL GLAZE 220 5%	1/10W
IC004	8-759-328-12	IC Z8622812PSC		R009	1-216-033-00	METAL GLAZE 220 5%	1/10W
IC005	8-759-280-75	IC ST24C01CB1		R010	1-216-073-00	METAL GLAZE 10K 5%	1/10W
IC006	8-759-403-44	IC MN1280-S		R011	1-216-033-00	METAL GLAZE 220 5%	1/10W
IC301	8-752-063-50	IC CXA1477AS		R012	1-216-033-00	METAL GLAZE 220 5%	1/10W
IC302	8-759-701-75	IC NJW7805FA		R013	1-216-073-00	METAL GLAZE 10K 5%	1/10W
		<COIL>		R014	1-216-073-00	METAL GLAZE 10K 5%	1/10W
L003	1-410-470-11	INDUCTOR 10UH		R015	1-216-033-00	METAL GLAZE 220 5%	1/10W



REF. NO.	PART NO.	DESCRIPTION	REMARK	REF. NO.	PART NO.	DESCRIPTION	REMARK
R018	1-216-049-00	METAL GLAZE 1K 5%	1/10W	R086	1-216-097-00	METAL GLAZE 100K 5%	1/10W
R019	1-216-033-00	METAL GLAZE 220 5%	1/10W	R087	1-216-073-00	METAL GLAZE 10K 5%	1/10W
R020	1-216-033-00	METAL GLAZE 220 5%	1/10W	R088	1-216-089-00	METAL GLAZE 47K 5%	1/10W
R021	1-216-033-00	METAL GLAZE 220 5%	1/10W	R089	1-216-065-00	METAL GLAZE 4.7K 5%	1/10W
R022	1-216-097-00	METAL GLAZE 100K 5%	1/10W	R090	1-216-073-00	METAL GLAZE 10K 5%	1/10W
R023	1-216-121-00	METAL GLAZE 1M 5%	1/10W	R101	1-216-065-00	METAL GLAZE 4.7K 5%	1/10W
R024	1-216-065-00	METAL GLAZE 4.7K 5%	1/10W	R102	1-216-089-00	METAL GLAZE 47K 5%	1/10W
R025	1-216-073-00	METAL GLAZE 10K 5%	1/10W	R103	1-216-045-00	METAL GLAZE 680 5%	1/10W
R026	1-216-073-00	METAL GLAZE 10K 5%	1/10W	R104	1-216-033-00	METAL GLAZE 220 5%	1/10W
R027	1-216-089-00	METAL GLAZE 47K 5%	1/10W	R106	1-216-033-00	METAL GLAZE 220 5%	1/10W
R028	1-216-065-00	METAL GLAZE 4.7K 5%	1/10W	R107	1-216-033-00	METAL GLAZE 220 5%	1/10W
R029	1-216-065-00	METAL GLAZE 4.7K 5%	1/10W	R108	1-216-033-00	METAL GLAZE 220 5%	1/10W
R031	1-216-065-00	METAL GLAZE 4.7K 5%	1/10W	R109	1-216-033-00	METAL GLAZE 220 5%	1/10W
R032	1-216-065-00	METAL GLAZE 4.7K 5%	1/10W	R110	1-216-033-00	METAL GLAZE 220 5%	1/10W
R033	1-216-065-00	METAL GLAZE 4.7K 5%	1/10W	R111	1-216-049-00	METAL GLAZE 1K 5%	1/10W
R034	1-216-073-00	METAL GLAZE 10K 5%	1/10W	R112	1-216-089-00	METAL GLAZE 47K 5%	1/10W
R035	1-216-033-00	METAL GLAZE 220 5%	1/10W	R113	1-216-089-00	METAL GLAZE 47K 5%	1/10W
R036	1-216-025-00	METAL GLAZE 100 5%	1/10W	R114	1-216-065-00	METAL GLAZE 4.7K 5%	1/10W
R037	1-216-033-00	METAL GLAZE 220 5%	1/10W	R115	1-216-065-00	METAL GLAZE 4.7K 5%	1/10W
R038	1-216-033-00	METAL GLAZE 220 5%	1/10W	R116	1-216-065-00	METAL GLAZE 4.7K 5%	1/10W
R039	1-216-025-00	METAL GLAZE 100 5%	1/10W	R117	1-216-047-00	METAL GLAZE 820 5%	1/10W
R040	1-216-033-00	METAL GLAZE 220 5%	1/10W	R118	1-216-047-00	METAL GLAZE 820 5%	1/10W
R041	1-216-033-00	METAL GLAZE 220 5%	1/10W	R119	1-216-047-00	METAL GLAZE 820 5%	1/10W
R042	1-216-033-00	METAL GLAZE 220 5%	1/10W	R120	1-216-033-00	METAL GLAZE 220 5%	1/10W
R043	1-216-073-00	METAL GLAZE 10K 5%	1/10W	R300	1-216-025-00	METAL GLAZE 100 5%	1/10W
R044	1-216-089-00	METAL GLAZE 47K 5%	1/10W	R301	1-216-059-00	METAL GLAZE 2.7K 5%	1/10W
R045	1-216-033-00	METAL GLAZE 220 5%	1/10W	R302	1-216-049-00	METAL GLAZE 1K 5%	1/10W
R046	1-216-033-00	METAL GLAZE 220 5%	1/10W	R303	1-216-049-00	METAL GLAZE 1K 5%	1/10W
R047	1-216-033-00	METAL GLAZE 220 5%	1/10W	R304	1-216-049-00	METAL GLAZE 1K 5%	1/10W
R048	1-216-073-00	METAL GLAZE 10K 5%	1/10W	R305	1-216-025-00	METAL GLAZE 100 5%	1/10W
R049	1-216-033-00	METAL GLAZE 220 5%	1/10W	R306	1-216-025-00	METAL GLAZE 100 5%	1/10W
R050	1-216-049-00	METAL GLAZE 1K 5%	1/10W	R307	1-216-057-00	METAL GLAZE 2.2K 5%	1/10W
R051	1-216-049-00	METAL GLAZE 1K 5%	1/10W	R308	1-216-073-00	METAL GLAZE 10K 5%	1/10W
R052	1-216-065-00	METAL GLAZE 4.7K 5%	1/10W	R309	1-216-025-00	METAL GLAZE 100 5%	1/10W
R054	1-216-073-00	METAL GLAZE 10K 5%	1/10W	R310	1-216-081-00	METAL GLAZE 22K 5%	1/10W
R055	1-216-049-00	METAL GLAZE 1K 5%	1/10W	R311	1-216-025-00	METAL GLAZE 100 5%	1/10W
R056	1-216-049-00	METAL GLAZE 1K 5%	1/10W	R312	1-216-033-00	METAL GLAZE 220 5%	1/10W
R057	1-216-065-00	METAL GLAZE 4.7K 5%	1/10W	R313	1-216-081-00	METAL GLAZE 22K 5%	1/10W
R058	1-216-073-00	METAL GLAZE 10K 5%	1/10W	R314	1-216-033-00	METAL GLAZE 220 5%	1/10W
R059	1-216-295-00	CONDUCTOR, CHIP		R315	1-216-067-00	METAL GLAZE 5.6K 5%	1/10W
R060	1-216-065-00	METAL GLAZE 4.7K 5%	1/10W	R317	1-216-033-00	METAL GLAZE 220 5%	1/10W
R062	1-216-085-00	METAL GLAZE 33K 5%	1/10W	R318	1-216-071-00	METAL GLAZE 8.2K 5%	1/10W
R063	1-216-041-00	METAL GLAZE 470 5%	1/10W	R319	1-216-190-00	METAL GLAZE 470 5%	1/8W
R064	1-216-065-00	METAL GLAZE 4.7K 5%	1/10W	R320	1-216-065-00	METAL GLAZE 4.7K 5%	1/10W
R065	1-216-097-00	METAL GLAZE 100K 5%	1/10W	R321	1-216-190-00	METAL GLAZE 470 5%	1/8W
R066	1-216-049-00	METAL GLAZE 1K 5%	1/10W	R323	1-216-295-00	CONDUCTOR, CHIP	
R067	1-216-049-00	METAL GLAZE 1K 5%	1/10W	R324	1-216-025-00	METAL GLAZE 100 5%	1/10W
R068	1-216-049-00	METAL GLAZE 1K 5%	1/10W	R325	1-216-043-91	METAL GLAZE 560 5%	1/10W
R069	1-216-073-00	METAL GLAZE 10K 5%	1/10W	R326	1-216-077-00	METAL GLAZE 15K 5%	1/10W
R071	1-216-073-00	METAL GLAZE 10K 5%	1/10W	R327	1-216-033-00	METAL GLAZE 220 5%	1/10W
R072	1-216-041-00	METAL GLAZE 470 5%	1/10W	R328	1-216-025-00	METAL GLAZE 100 5%	1/10W
R073	1-216-049-00	METAL GLAZE 1K 5%	1/10W	R329	1-216-085-00	METAL GLAZE 33K 5%	1/10W
R074	1-216-049-00	METAL GLAZE 1K 5%	1/10W	R330	1-216-039-00	METAL GLAZE 390 5%	1/10W
R075	1-216-069-00	METAL GLAZE 6.8K 5%	1/10W	R331	1-216-059-00	METAL GLAZE 2.7K 5%	1/10W
R076	1-216-089-00	METAL GLAZE 47K 5%	1/10W	R332	1-216-049-00	METAL GLAZE 1K 5%	1/10W
R077	1-216-097-00	METAL GLAZE 100K 5%	1/10W	R333	1-208-810-11	METAL CHIP 15K 0.50%	1/10W
R078	1-216-097-00	METAL GLAZE 100K 5%	1/10W	R335	1-216-033-00	METAL GLAZE 220 5%	1/10W
R079	1-216-081-00	METAL GLAZE 22K 5%	1/10W	R336	1-216-033-00	METAL GLAZE 220 5%	1/10W
R080	1-216-023-00	METAL GLAZE 82 5%	1/10W	R337	1-216-049-00	METAL GLAZE 1K 5%	1/10W
R081	1-216-041-00	METAL GLAZE 470 5%	1/10W	R338	1-216-049-00	METAL GLAZE 1K 5%	1/10W
R082	1-216-093-00	METAL GLAZE 68K 5%	1/10W	R339	1-216-655-11	METAL CHIP 1.5K 0.50%	1/10W
R083	1-216-065-00	METAL GLAZE 4.7K 5%	1/10W	R340	1-216-033-00	METAL GLAZE 220 5%	1/10W
R084	1-216-073-00	METAL GLAZE 10K 5%	1/10W	R341	1-216-033-00	METAL GLAZE 220 5%	1/10W
R085	1-216-089-00	METAL GLAZE 47K 5%	1/10W				

The components identified by shading and mark Δ are critical for safety. Replace only with part number specified.

Les composants identifiés par une trame et une marque Δ sont critiques pour la sécurité. Ne les remplacer que par une pièce portant le numéro spécifié.



REF. NO.	PART NO.	DESCRIPTION	REMARK	REF. NO.	PART NO.	DESCRIPTION	REMARK
R342	1-216-033-00	METAL GLAZE 220 5%	1/10W				(KP-41T15)
R343	1-216-077-00	METAL GLAZE 15K 5%	1/10W				
R344	1-216-073-00	METAL GLAZE 10K 5%	1/10W				
R345	1-216-025-00	METAL GLAZE 100 5%	1/10W				
R346	1-216-037-00	METAL GLAZE 330 5%	1/10W				
R347	1-216-041-00	METAL GLAZE 470 5%	1/10W				
R348	1-216-049-00	METAL GLAZE 1K 5%	1/10W				(KP-41T15)
R349	1-216-033-00	METAL GLAZE 220 5%	1/10W				
R350	1-216-033-00	METAL GLAZE 220 5%	1/10W				
R351	1-216-033-00	METAL GLAZE 220 5%	1/10W				
R352	1-216-057-00	METAL GLAZE 2.2K 5%	1/10W				(KP-41T15)
R353	1-216-069-00	METAL GLAZE 6.8K 5%	1/10W				(KP-41T15)
R354	1-216-053-00	METAL GLAZE 1.5K 5%	1/10W				
R355	1-216-071-00	METAL GLAZE 8.2K 5%	1/10W				
R356	1-216-031-00	METAL GLAZE 180 5%	1/10W				(KP-41T15)
R357	1-216-031-00	METAL GLAZE 180 5%	1/10W				(KP-41T15)
R358	1-216-049-00	METAL GLAZE 1K 5%	1/10W				(KP-41T15)
R359	1-216-037-00	METAL GLAZE 330 5%	1/10W				(KP-41T15)
R360	1-216-035-00	METAL GLAZE 270 5%	1/10W				
R361	1-216-049-00	METAL GLAZE 1K 5%	1/10W				(KP-41T15)
R362	1-216-035-00	METAL GLAZE 270 5%	1/10W				(KP-41T15)
R363	1-216-049-00	METAL GLAZE 1K 5%	1/10W				(KP-41T15)
R364	1-216-025-00	METAL GLAZE 100 5%	1/10W				(KP-41T15)
R366	1-216-053-00	METAL GLAZE 1.5K 5%	1/10W				(KP-41T15)
R367	1-216-057-00	METAL GLAZE 2.2K 5%	1/10W				(KP-41T15)
R368	1-216-025-00	METAL GLAZE 100 5%	1/10W				(KP-41T15)
R369	1-216-061-00	METAL GLAZE 3.3K 5%	1/10W				(KP-41T15)
R370	1-216-033-00	METAL GLAZE 220 5%	1/10W				
R371	1-216-049-00	METAL GLAZE 1K 5%	1/10W				(KP-41T15)
R372	1-216-051-00	METAL GLAZE 1.2K 5%	1/10W				(KP-41T15)
R373	1-216-035-00	METAL GLAZE 270 5%	1/10W				(KP-41T15)
R374	1-216-085-00	METAL GLAZE 33K 5%	1/10W				(KP-41T15)
R375	1-216-075-00	METAL GLAZE 12K 5%	1/10W				(KP-41T15)
R376	1-216-093-00	METAL GLAZE 68K 5%	1/10W				(KP-41T15)
R377	1-216-043-91	METAL GLAZE 560 5%	1/10W				(KP-41T15)
R378	1-216-059-00	METAL GLAZE 2.7K 5%	1/10W				(KP-41T15)
R379	1-216-083-00	METAL GLAZE 27K 5%	1/10W				(KP-41T15)
R380	1-216-097-00	METAL GLAZE 100K 5%	1/10W				(KP-41T15)
R381	1-216-071-00	METAL GLAZE 8.2K 5%	1/10W				(KP-41T15)
R382	1-216-085-00	METAL GLAZE 33K 5%	1/10W				
R383	1-216-043-91	METAL GLAZE 560 5%	1/10W				(KP-41T15)
R384	1-216-053-00	METAL GLAZE 1.5K 5%	1/10W				(KP-41T15)
R385	1-216-085-00	METAL GLAZE 33K 5%	1/10W				(KP-41T15)
R386	1-216-121-00	METAL GLAZE 1M 5%	1/10W				(KP-41T15)
R387	1-216-049-00	METAL GLAZE 1K 5%	1/10W				(KP-41T15)
R388	1-216-295-00	CONDUCTOR, CHIP					(KP-41T15)
R389	1-216-033-00	METAL GLAZE 220 5%	1/10W				(KP-41T15)
R390	1-216-033-00	METAL GLAZE 220 5%	1/10W				
R391	1-216-061-00	METAL GLAZE 3.3K 5%	1/10W				
R392	1-216-059-00	METAL GLAZE 2.7K 5%	1/10W				
<CRYSTAL>							
X001	1-579-917-11	VIBRATOR, CRYSTAL					
X301	1-577-611-11	OSCILLATOR, CERAMIC					
X302	1-567-505-11	OSCILLATOR, CRYSTAL					

*A-1316-212-A G BOARD, COMPLETE *****							
*4-047-936-01 PLATE, SHIELD, PIT 4-382-854-11 SCREW (M3X10), P, SW (+)							
<CAPACITOR>							
C601	Δ 1-136-311-51	FILM 0.47MF	20%	125V			
C602	Δ 1-164-486-51	CERAMIC 0.0022MF	20%	400V			
C603	Δ 1-164-486-51	CERAMIC 0.0022MF	20%	400V			
C604	Δ 1-125-692-11	ELECT (BLOCK) 820MF	20%	200V			
C605	Δ 1-125-692-11	ELECT (BLOCK) 820MF	20%	200V			
C608	1-164-645-11	CERAMIC 1000PF	10%	500V			
C609	1-164-645-11	CERAMIC 1000PF	10%	500V			
C610	1-136-173-00	FILM 0.47MF	5%	50V			
C611	1-136-171-00	FILM 0.33MF	5%	50V			
C612	1-136-173-00	FILM 0.47MF	5%	50V			
C613	1-136-171-00	FILM 0.33MF	5%	50V			
C614	1-164-735-11	CAP, CERAMIC 1500PF					
C615	1-129-720-00	FILM 0.033MF	5%	630V			
C616	Δ 1-136-311-51	FILM 0.47MF	20%	125V			
C618	Δ 1-161-740-00	CERAMIC 470PF	10%	400V			
C619	Δ 1-161-740-00	CERAMIC 470PF	10%	400V			
C651	1-128-548-11	ELECT 4700MF	20%	25V			
C652	1-128-548-11	ELECT 4700MF	20%	25V			
C653	1-162-318-11	CERAMIC 0.001MF	10%	500V			
C656	1-128-548-11	ELECT 4700MF	20%	25V			
C657	1-126-926-11	ELECT 1000MF	20%	10V			
C658	1-126-768-11	ELECT 2200MF	20%	16V			
C659	1-126-944-11	ELECT 3300MF	20%	25V			
C660	1-164-644-11	CERAMIC 330PF	10%	500V			
C661	1-123-024-21	ELECT 33MF		160V			
C662	1-107-636-11	ELECT 10MF	20%	160V			
C663	1-126-948-11	ELECT 100MF	20%	35V			
C664	1-126-235-11	ELECT 100MF	20%	6.3V			
C665	1-126-964-11	ELECT 10MF	20%	50V			
C667	1-126-941-11	ELECT 470MF	20%	25V			



Les composants identifiés par une trame et une marque Δ sont critiques pour la sécurité. Ne les remplacer que par une pièce portant le numéro spécifié.

The components identified by shading and mark Δ are critical for safety. Replace only with part number specified.

REF.NO.	PART NO.	DESCRIPTION	REMARK
C668	1-104-664-11	ELECT 47MF	20% 25V
C669	1-162-318-11	CERAMIC 0.001MF	10% 500V
C670	1-104-664-11	ELECT 47MF	20% 25V
C671	1-104-664-11	ELECT 47MF	20% 25V
C672	1-104-665-11	ELECT 100MF	20% 25V
C673	1-104-664-11	ELECT 47MF	20% 25V
C674	1-104-664-11	ELECT 47MF	20% 25V
C675	1-104-664-11	ELECT 47MF	20% 25V
C676	1-104-664-11	ELECT 47MF	20% 25V
C677	1-125-473-11	ELECT (BLOCK) 1000MF	20% 160V
C678	1-107-635-11	ELECT 4.7MF	20% 160V
C679	1-164-644-11	CERAMIC 330PF	10% 500V
C680	1-124-903-11	ELECT 1MF	20% 50V
C682	1-124-903-11	ELECT 1MF	20% 50V
C683	1-107-635-11	ELECT 4.7MF	20% 160V
C690	1-126-934-11	ELECT 220MF	20% 16V
<CONNECTOR>			
CN606	1-695-915-11	TAB (CONTACT)	
CN615	1-695-915-11	TAB (CONTACT)	
CN616	*1-564-507-11	PLUG, CONNECTOR 4P	
CN617	*1-580-843-11	PIN, CONNECTOR (POWER)	
CN624	*1-564-507-11	PLUG, CONNECTOR 4P	
CN625	*1-564-513-11	PLUG, CONNECTOR 10P	
CN626	*1-564-506-11	PLUG, CONNECTOR 3P	
CN653	*1-564-507-11	PLUG, CONNECTOR 4P	
CN681	*1-573-986-11	PIN, CONNECTOR (PC BOARD) 5P	
<DIODE>			
D601	Δ 8-719-052-29	DIODE 1N4S860-F	
D604	8-719-911-19	DIODE 1SS119-25	
D605	8-719-911-19	DIODE 1SS119-25	
D606	8-719-911-19	DIODE 1SS119-25	
D607	8-719-911-19	DIODE 1SS119-25	
D608	8-719-911-19	DIODE 1SS119-25	
D609	8-719-911-19	DIODE 1SS119-25	
D610	8-719-911-19	DIODE 1SS119-25	
D611	8-719-911-19	DIODE 1SS119-25	
D651	8-719-052-91	DIODE D4SBS4-F	
D655	8-719-052-92	DIODE D10SBS4F	
D656	8-719-022-97	DIODE S2S4MF	
D657	8-719-022-97	DIODE S2S4MF	
D658	8-719-022-97	DIODE S2S4MF	
D659	8-719-022-97	DIODE S2S4MF	
D660	8-719-052-86	DIODE D2L40-TA	
D661	8-719-052-86	DIODE D2L40-TA	
D662	8-719-052-31	DIODE D1NL40-TR2	
D663	8-719-052-31	DIODE D1NL40-TR2	
D664	8-719-510-26	DIODE D1NL20	
D665	8-719-911-19	DIODE 1SS119-25	
D666	8-719-110-58	DIODE RD22ESB3	
D667	8-719-110-22	DIODE RD11ESB2	
D669	8-719-911-19	DIODE 1SS119-25	
D670	8-719-110-41	DIODE RD15ESB2	
D671	8-719-911-19	DIODE 1SS119-25	
D672	8-719-109-54	DIODE RD2.2ESB2	
D673	8-719-110-49	DIODE RD18ESB2	
D674	8-719-911-19	DIODE 1SS119-25	
D675	8-719-109-85	DIODE RD5.1ESB2	
D676	8-719-911-19	DIODE 1SS119-25	
D677	8-719-911-19	DIODE 1SS119-25	
D678	8-719-911-19	DIODE 1SS119-25	

REF.NO.	PART NO.	DESCRIPTION	REMARK
D679	8-719-911-19	DIODE 1SS119-25	
D680	8-719-200-82	DIODE 11ES2	
D681	8-719-200-82	DIODE 11ES2	
D682	8-719-200-82	DIODE 11ES2	
D683	8-719-200-82	DIODE 11ES2	
D685	8-719-911-19	DIODE 1SS119-25	
D686	8-719-911-19	DIODE 1SS119-25	
D687	8-719-109-51	DIODE RD2.0ESB2	
D688	8-719-911-19	DIODE 1SS119-25	
D689	8-719-911-19	DIODE 1SS119-25	
D690	8-719-109-89	DIODE RD5.6ESB2	
D691	8-719-911-19	DIODE 1SS119-25	
D693	8-719-911-19	DIODE 1SS119-25	
<FUSE>			
F601	Δ 1-576-193-11	FUSE (6.3A/125V)	
	1-533-223-11	CLIP, FUSE; F601	
<FERRITE BEAD>			
FB651	1-410-396-41	FERRITE BEAD INDUCTOR 0.45UH	
FB652	1-410-396-41	FERRITE BEAD INDUCTOR 0.45UH	
<IC>			
IC651	Δ 1-810-051-11	POWER MODULE DM-48	
IC652	8-759-701-79	IC NJM7812FA	
<COIL>			
L651	1-403-588-11	CIL, CHOKE 22UH	
L652	1-403-588-11	CIL, CHOKE 22UH	
L653	1-412-519-11	INDUCTOR 3.3UH	
L654	1-403-588-11	CIL, CHOKE 22UH	
L655	1-403-588-11	CIL, CHOKE 22UH	
L656	1-412-519-11	INDUCTOR 3.3UH	
L657	1-403-588-11	CIL, CHOKE 22UH	
L658	1-403-588-11	CIL, CHOKE 22UH	
<TRANSISTOR>			
Q601	8-729-019-49	TRANSISTOR 2SC4834M	
Q602	8-729-019-49	TRANSISTOR 2SC4834M	
Q651	8-729-820-82	TRANSISTOR 2SA1208-S	
Q652	8-729-119-76	TRANSISTOR 2SA1175-HFE	
Q653	8-729-230-45	TRANSISTOR 2SC2458-YGR	
Q654	8-729-119-76	TRANSISTOR 2SA1175-HFE	
Q655	8-729-230-45	TRANSISTOR 2SC2458-YGR	
Q656	8-729-119-76	TRANSISTOR 2SA1175-HFE	
Q657	8-729-119-78	TRANSISTOR 2SC2785-HFE	
Q658	8-729-119-76	TRANSISTOR 2SA1175-HFE	
Q659	8-729-119-76	TRANSISTOR 2SA1175-HFE	
Q660	8-729-119-76	TRANSISTOR 2SA1175-HFE	
Q661	8-729-119-76	TRANSISTOR 2SA1175-HFE	
Q662	8-729-119-76	TRANSISTOR 2SA1175-HFE	
Q663	8-729-119-76	TRANSISTOR 2SA1175-HFE	
<RESISTOR>			
R602	Δ 1-202-888-91	SOLID 2.2M 20% 1/2W	
R603	Δ 1-205-997-11	WIREWOUND 2.2 5% 10W	
R604	Δ 1-247-891-91	CARBON 330K 5% 1/4W	
R605	Δ 1-247-891-91	CARBON 330K 5% 1/4W	

The components identified by shading and mark Δ are critical for safety. Replace only with part number specified.

Les composants identifiés par une trame et une marque Δ sont critiques pour la sécurité. Ne les remplacer que par une pièce portant le numéro spécifié.



REF.NO.	PART NO.	DESCRIPTION	REMARK
R606	Δ 1-202-933-61	FUSIBLE	0.1 10% 1/2W F
R607	1-247-891-00	CARBON	330K 5% 1/4W
R608	1-247-891-00	CARBON	330K 5% 1/4W
R609	1-216-369-00	METAL OXIDE	1 5% 2W F
R610	1-247-891-00	CARBON	330K 5% 1/4W
R611	1-247-891-00	CARBON	330K 5% 1/4W
R612	1-216-369-00	METAL OXIDE	1 5% 2W F
R613	1-247-791-91	CARBON	22 5% 1/4W
R614	1-247-791-91	CARBON	22 5% 1/4W
R615	1-247-791-91	CARBON	22 5% 1/4W
R616	1-247-791-91	CARBON	22 5% 1/4W
R631	1-247-863-91	CARBON	22K 5% 1/4W
R632	1-247-807-31	CARBON	100 5% 1/4W
R633	1-247-807-31	CARBON	100 5% 1/4W
R634	1-249-417-11	CARBON	1K 5% 1/4W
R635	1-249-425-11	CARBON	4.7K 5% 1/4W
R636	1-249-413-11	CARBON	470 5% 1/4W
R651	1-216-370-11	METAL OXIDE	1.2 5% 2W F
R653	1-249-418-11	CARBON	1.2K 5% 1/4W F
R654	1-215-473-00	METAL	150K 1% 1/4W
R655	1-249-441-11	CARBON	100K 5% 1/4W
R656	1-216-369-00	METAL OXIDE	1 5% 2W F
R657	1-249-429-11	CARBON	10K 5% 1/4W
R658	1-247-883-00	CARBON	150K 5% 1/4W
R659	1-249-417-11	CARBON	1K 5% 1/4W F
R660	1-249-417-11	CARBON	1K 5% 1/4W
R661	1-215-471-00	METAL	120K 1% 1/4W
R662	Δ 1-215-472-91	METAL	20K 1% 1/4W
R664	1-249-429-11	CARBON	10K 5% 1/4W
R665	1-249-425-11	CARBON	4.7K 5% 1/4W
R666	1-249-429-11	CARBON	10K 5% 1/4W
R667	1-249-429-11	CARBON	10K 5% 1/4W
R670	1-247-895-00	CARBON	470K 5% 1/4W
R672	1-247-807-31	CARBON	100 5% 1/4W
R673	1-249-423-11	CARBON	3.3K 5% 1/4W
R674	1-249-413-11	CARBON	470 5% 1/4W
R675	1-249-429-11	CARBON	10K 5% 1/4W
R676	1-249-421-11	CARBON	2.2K 5% 1/4W
R677	1-249-417-11	CARBON	1K 5% 1/4W
R678	1-249-423-11	CARBON	3.3K 5% 1/4W
R679	1-249-423-11	CARBON	3.3K 5% 1/4W
R680	1-249-413-11	CARBON	470 5% 1/4W
R681	1-249-425-11	CARBON	4.7K 5% 1/4W
R682	1-249-403-11	CARBON	68 5% 1/4W
R683	1-249-417-11	CARBON	1K 5% 1/4W
R684	1-249-417-11	CARBON	1K 5% 1/4W
R685	1-247-863-91	CARBON	22K 5% 1/4W
R686	1-249-429-11	CARBON	10K 5% 1/4W
R687	1-249-423-11	CARBON	3.3K 5% 1/4W
R688	1-249-423-11	CARBON	3.3K 5% 1/4W
R689	1-249-429-11	CARBON	10K 5% 1/4W
R690	1-247-863-91	CARBON	22K 5% 1/4W
R691	1-249-417-11	CARBON	1K 5% 1/4W
R693	1-249-425-11	CARBON	4.7K 5% 1/4W
R694	1-249-425-11	CARBON	4.7K 5% 1/4W
R695	1-249-429-11	CARBON	10K 5% 1/4W
R697	1-249-413-11	CARBON	470 5% 1/4W
R698	1-249-429-11	CARBON	10K 5% 1/4W
R699	1-249-417-11	CARBON	1K 5% 1/4W

<RELAY>

RY601A	1-755-032-11	RELAY
RY602A	1-755-032-11	RELAY

REF.NO.	PART NO.	DESCRIPTION	REMARK
<TRANSFORMER>			
T601	Δ 1-427-850-11	TRANSFORMER, LINE FILTER	
T602	Δ 1-427-865-11	TRANSFORMER, CONVERTER (PT)	
T603	Δ 1-427-865-11	TRANSFORMER, POWER	
T604	Δ 1-427-864-11	TRANSFORMER, CONVERTER (PRT)	
T605	Δ 1-427-850-11	TRANSFORMER, LINE FILTER	

		*A-1331-408-A	CR BOARD, COMPLETE

<CAPACITOR>			
C701	1-104-664-11	ELECT	47MF 20% 25V
C702	1-107-662-11	ELECT	22MF 20% 250V
C703	1-161-754-00	CERAMIC	0.001MF 10% 2KV
C704	1-126-768-11	ELECT	2200MF 20% 16V
C705	1-102-050-00	CERAMIC	0.01MF 99% 500V
C706	1-102-965-00	CERAMIC	39PF 5% 50V
C707	1-102-129-00	CERAMIC	0.01MF 10% 50V
C708	1-104-664-11	ELECT	47MF 20% 25V
C709	1-107-651-11	ELECT	4.7MF 20% 250V
C710	1-102-157-00	CERAMIC	560PF 10% 500V
C714	1-162-115-00	CERAMIC	330PF 10% 2KV
<CONNECTOR>			
CN701	*1-508-784-00	PIN, CONNECTOR (5MM PITCH) 1P	
CN702	*1-564-510-11	PLUG, CONNECTOR 7P	
CN703	*1-564-512-11	PLUG, CONNECTOR 9P	
CN704	*1-564-512-11	PLUG, CONNECTOR 9P	
CN705	*1-564-511-11	PLUG, CONNECTOR 8P	
CN706	1-695-915-11	TAB (CONTACT)	
CN707	1-564-512-11	SOCKET, PICTURE TUBE	
CN709	*1-564-506-11	PLUG, CONNECTOR 3P	
<DIODE>			
D701	8-719-911-19	DIODE 1SS119-25	
D702	8-719-911-19	DIODE 1SS119-25	
D703	8-719-911-19	DIODE 1SS119-25	
D704	8-719-110-36	DIODE RD13ESB2	
D705	8-719-987-87	DIODE ERA82-009	
D706	8-719-911-19	DIODE 1SS119-25	
D707	8-719-110-36	DIODE RD13ESB2	
D708	8-719-901-83	DIODE 1SS83	
D710	8-719-109-89	DIODE RD5.6ESB2	
D711	8-719-911-19	DIODE 1SS119-25	
D713	8-719-510-48	DIODE D1N20R	
D715	8-719-901-83	DIODE 1SS83	
D716	8-719-110-36	DIODE RD13ESB2	
D717	8-719-110-36	DIODE RD13ESB2	
<IC>			
IC701	8-759-168-72	IC TDA6101Q	
<COIL>			
L701	1-408-429-00	INDUCTOR 470UH	
L703	1-408-159-00	COIL, SPOOK CHOKE 3.3UH	

CR CG CB

Les composants identifiés par une trame et une marque Δ sont critiques pour la sécurité. Ne les remplacer que par une pièce portant le numéro spécifié.

The components identified by shading and mark Δ are critical for safety. Replace only with part number specified.

REF.NO. PART NO. DESCRIPTION

<NEON LAMP>

NL701 1-519-108-XX LAMP, NEON

<TRANSISTOR>

Q701 8-729-119-76 TRANSISTOR 2SA1175-HFE

<RESISTOR>

R701 1-215-411-00 METAL 390 1% 1/4W
R702 1-215-414-00 METAL 510 1% 1/4W
R704 1-202-847-00 SOLID 560K 20% 1/2W
R706 1-249-407-11 CARBON 150 5% 1/4W
R707 1-215-423-00 METAL 1.2K 1% 1/4W

R708 1-202-883-11 SOLID 680K 20% 1/2W
R709 1-215-437-00 METAL 4.7K 1% 1/4W
R710 1-215-427-00 METAL 1.8K 1% 1/4W
R711 1-215-427-00 METAL 1.8K 1% 1/4W
R712 1-215-903-11 METAL OXIDE 68K 5% 2W F

R713 1-202-818-00 SOLID 1K 20% 1/2W
R714 1-202-818-00 SOLID 1K 20% 1/2W
R715 1-249-436-11 CARBON 39K 5% 1/4W
R716 1-249-437-11 CARBON 47K 5% 1/4W
R718 1-249-417-11 CARBON 1K 5% 1/4W

R719 1-247-807-31 CARBON 100 5% 1/4W
R720 1-249-437-11 CARBON 47K 5% 1/4W
R721 1-202-549-00 SOLID 100 20% 1/2W
R722 1-202-549-00 SOLID 100 20% 1/2W

<SPARK GAP>

SG701 1-519-422-11 GAP, SPARK
SG702 1-519-422-11 GAP, SPARK
SG703 1-519-422-11 GAP, SPARK

*A-1331-409-A CG BOARD, COMPLETE

<CAPACITOR>

C731 1-161-754-00 CERAMIC 0.001MF 10% 2KV
C732 1-107-662-11 ELECT 22MF 20% 250V
C733 1-102-050-00 CERAMIC 0.01MF 99% 500V
C736 1-126-964-11 ELECT 10MF 20% 50V
C738 1-107-651-11 ELECT 4.7MF 20% 250V

C739 1-164-066-11 CERAMIC 68PF 5% 50V
C740 1-126-964-11 ELECT 10MF 20% 50V
C741 1-102-157-00 CERAMIC 560PF 10% 500V
C742 1-162-115-00 CERAMIC 330PF 10% 2KV

<CONNECTOR>

CN731 *1-508-784-00 PIN, CONNECTOR (5MM PITCH) 1P
CN732 *1-564-512-11 PLUG, CONNECTOR 9P
CN733 *1-564-512-11 PLUG, CONNECTOR 9P
CN734 *1-564-511-11 PLUG, CONNECTOR 8P
CN735 *1-564-509-11 PLUG, CONNECTOR 6P

CN736 1-695-915-11 TAB (CONTACT)

CN738Δ 1-251-179-11 SOCKET, PICTURE TUBE

<DIODE>

REMARK

REF.NO. PART NO.

DESCRIPTION

REMARK

D731 8-719-110-36 DIODE RD13ESB2
D732 8-719-901-83 DIODE 1SS83
D735 8-719-901-83 DIODE 1SS83
D736 8-719-510-48 DIODE D1N20R
D737 8-719-110-36 DIODE RD13ESB2

<IC>

IC731 8-759-168-72 IC TDA6101Q

<COIL>

L731 1-408-429-00 INDUCTOR 470UH
L732 1-408-159-00 COIL, SPOOK CHOKE 3.3UH

<NEON LAMP>

NL731 1-519-108-XX LAMP, NEON

<RESISTOR>

R731 1-202-847-00 SOLID 560K 20% 1/2W
R733 1-202-883-11 SOLID 680K 20% 1/2W
R734 1-202-818-00 SOLID 1K 20% 1/2W
R735 1-249-407-11 CARBON 150 5% 1/4W
R736 1-249-441-11 CARBON 100K 5% 1/4W

R737 1-202-818-00 SOLID 1K 20% 1/2W
R738 1-202-549-00 SOLID 100 20% 1/2W
R739 1-215-420-00 METAL 910 1% 1/4W
R740 1-215-427-00 METAL 1.8K 1% 1/4W
R741 1-249-437-11 CARBON 47K 5% 1/4W

R742 1-215-903-11 METAL OXIDE 68K 5% 2W F

<SPARK GAP>

SG731 1-519-422-11 GAP, SPARK
SG732 1-519-422-11 GAP, SPARK
SG733 1-519-422-11 GAP, SPARK

*A-1331-410-A CB BOARD, COMPLETE

<CAPACITOR>

C761 1-161-754-00 CERAMIC 0.001MF 10% 2KV
C762 1-107-662-11 ELECT 22MF 20% 250V
C763 1-102-050-00 CERAMIC 0.01MF 99% 500V
C766 1-107-651-11 ELECT 4.7MF 20% 250V
C769 1-164-066-11 CERAMIC 68PF 5% 50V

C770 1-126-964-11 ELECT 10MF 20% 50V
C771 1-102-157-00 CERAMIC 560PF 10% 500V
C772 1-162-115-00 CERAMIC 330PF 10% 2KV

<CONNECTOR>

CN761 *1-508-784-00 PIN, CONNECTOR (5MM PITCH) 1P
CN762 *1-564-512-11 PLUG, CONNECTOR 9P
CN763 *1-564-509-11 PLUG, CONNECTOR 6P
CN766 1-695-915-11 TAB (CONTACT)

CN768Δ 1-251-179-11 SOCKET, PICTURE TUBE

<DIODE>

The components identified by shading and mark Δ are critical for safety. Replace only with part number specified.

Les composants identifiés par une trame et une marque Δ sont critiques pour la sécurité. Ne les remplacer que par une pièce portant le numéro spécifique.

CB E

REF.NO.	PART NO.	DESCRIPTION	REMARK	REF.NO.	PART NO.	DESCRIPTION	REMARK
D761	8-719-110-36	DIODE RD13ESB2		C814	1-124-122-11	ELECT 100MF	20% 50V
D762	8-719-901-83	DIODE 1SS83		C815	1-162-114-00	CERAMIC 0.0047MF	20% 2KV
D763	8-719-911-19	DIODE 1SS119-25		C818 Δ 1-102-835-11	FILM 0.015MF	5% 1.8KV	
D764	8-719-110-36	DIODE RD13ESB2		C819	1-130-489-00	FILM 0.033MF	5% 50V
D765	8-719-110-36	DIODE RD13ESB2		C820	1-124-902-00	ELECT 0.47MF	20% 50V
D767	8-719-901-83	DIODE 1SS83		C823	1-136-601-11	FILM 0.01MF	5% 630V
D768	8-719-510-48	DIODE DIN20R		C824	1-126-964-11	ELECT 10MF	20% 50V
D769	8-719-110-36	DIODE RD13ESB2		C825	1-162-318-11	CERAMIC 0.001MF	10% 500V
				C826	1-130-467-00	FILM 470PF	5% 50V
		<IC>		C827	1-107-652-11	ELECT 10MF	20% 250V
IC761	8-759-168-72	IC TDA6101Q		C828	1-111-036-91	ELECT 470MF	20% 16V
		<COIL>		C830	1-107-368-11	FILM 0.047MF	10% 200V
L761	1-408-429-00	INDUCTOR 470UH		C831	1-126-934-11	ELECT 220MF	20% 16V
L762	1-408-159-00	COIL, SPOOK CHOKE 3.3UH		C832	1-124-927-11	ELECT 4.7MF	20% 50V
		<NEON LAMP>		C901	1-163-117-00	CERAMIC CHIP 100PF	5% 50V
NL760	1-519-108-XX	LAMP, NEON		C902	1-137-370-11	FILM 0.01MF	5% 50V
		<RESISTOR>		C903	1-137-361-11	FILM 330PF	5% 50V
R761	1-202-847-00	SOLID 560K 20%	1/2W	C904	1-137-358-11	FILM 0.0001MF	5% 50V
R763	1-202-883-11	SOLID 680K 20%	1/2W	C905	1-104-665-11	ELECT 100MF	20% 25V
R764	1-202-818-00	SOLID 1K 20%	1/2W	C906	1-137-370-11	FILM 0.01MF	5% 50V
R767	1-202-818-00	SOLID 1K 20%	1/2W	C907	1-104-665-11	ELECT 100MF	20% 25V
R768	1-202-549-00	SOLID 100 20%	1/2W	C908	1-137-361-11	FILM 330PF	5% 50V
R769	1-215-421-00	METAL 1K 1%	1/4W	C909	1-124-903-11	ELECT 1MF	20% 50V
R770	1-249-426-11	CARBON 5.6K 5%	1/4W	C911	1-163-117-00	CERAMIC CHIP 100PF	5% 50V
R771	1-215-427-00	METAL 1.8K 1%	1/4W	C912	1-124-903-11	ELECT 1MF	20% 50V
R773	1-215-903-11	METAL OXIDE 68K 5%	2W F	C913	1-124-903-11	ELECT 1MF	20% 50V
R774	1-249-407-11	CARBON 150 5%	1/4W	C915	1-163-105-00	CERAMIC CHIP 33PF	5% 50V
R775	1-202-549-00	SOLID 100 20%	1/2W	C916	1-124-927-11	ELECT 4.7MF	20% 50V
		<SPARK GAP>		C917	1-126-964-11	ELECT 10MF	20% 50V
SG761	1-519-422-11	GAP, SPARK		C918	1-137-364-11	FILM 0.001MF	5% 50V
SG762	1-519-422-11	GAP, SPARK		C919	1-126-964-11	ELECT 10MF	20% 50V
SG763	1-519-422-11	GAP, SPARK		C920	1-124-902-00	ELECT 0.47MF	20% 50V
*****				C921	1-126-964-11	ELECT 10MF	20% 50V
*A-1341-885-A	E BOARD, COMPLETE			C923	1-126-964-11	ELECT 10MF	20% 50V
	*****			C924	1-126-940-11	ELECT 330MF	20% 16V
1-923-505-05	WIRE UL1007 AWG24 50MM GR			C925	1-137-372-11	FILM 0.022MF	5% 50V
4-365-216-00	SPACER, MICA			C926	1-104-665-11	ELECT 100MF	20% 25V
4-382-854-11	SCREW (M3X10), P, SW (+)			C927	1-137-364-11	FILM 0.001MF	5% 50V
		<CAPACITOR>		C929	1-137-416-11	FILM 0.01MF	10% 100V
C801	1-110-626-11	ELECT 330MF	20% 160V	C930	1-137-364-11	FILM 0.001MF	5% 50V
C802	1-163-117-00	CERAMIC CHIP 100PF	5% 50V	C931	1-126-967-11	ELECT 47MF	20% 50V
C803	1-110-626-11	ELECT 330MF	20% 160V	C932	1-124-903-11	ELECT 1MF	20% 50V
C805	1-136-173-00	FILM 0.47MF	5% 50V	C934	1-137-370-11	FILM 0.01MF	5% 50V
C806	1-102-030-00	CERAMIC 330PF	10% 500V	C935	1-137-399-11	FILM 0.1MF	10% 100V
C807	1-106-387-00	MYLAR 0.068MF	10% 200V	C936	1-126-964-11	ELECT 10MF	20% 50V
C808	1-107-636-11	ELECT 10MF	20% 160V	C937	1-126-964-11	ELECT 10MF	20% 50V
C809	1-104-664-11	ELECT 47MF	20% 25V	C938	1-126-940-11	ELECT 330MF	20% 16V
C810	1-130-481-00	FILM 0.0068MF	5% 50V	C939	1-126-964-11	ELECT 10MF	20% 50V
C811	1-137-475-11	FILM 2.2MF	10% 250V	C940	1-104-663-11	ELECT 33MF	20% 25V
C812	1-128-551-11	ELECT 22MF	20% 50V	C941	1-126-964-11	ELECT 10MF	20% 50V
				C942	1-104-663-11	ELECT 33MF	20% 25V
				C943	1-128-551-11	ELECT 22MF	20% 50V
				C944	1-126-964-11	ELECT 10MF	20% 50V
				C945	1-126-964-11	ELECT 10MF	20% 50V
				C946	1-124-925-11	ELECT 2.2MF	20% 50V
				C947	1-104-665-11	ELECT 100MF	20% 25V
				C948	1-104-665-11	ELECT 100MF	20% 25V
				C949	1-126-964-11	ELECT 10MF	20% 50V
				C950	1-126-964-11	ELECT 10MF	20% 50V
				C951	1-124-903-11	ELECT 1MF	20% 50V
				C953	1-163-009-11	CERAMIC CHIP 0.001MF	10% 50V
				C954	1-163-009-11	CERAMIC CHIP 0.001MF	10% 50V
				C955	1-126-964-11	ELECT 10MF	20% 50V
				C980	1-137-368-11	FILM 0.0047MF	5% 50V



Les composants identifiés par une trame et une marque Δ sont critiques pour la sécurité. Ne les remplacer que par une pièce portant le numéro spécifié.

The components identified by shading and mark Δ are critical for safety. Replace only with part number specified.

REF. NO.	PART NO.	DESCRIPTION	REMARK	REF. NO.	PART NO.	DESCRIPTION	REMARK
		<CONDUCTOR CHIP>				<FERRITE BEAD>	
CJ901	1-216-295-00	CONDUCTOR, CHIP		FBO01	1-410-396-41	FERRITE BEAD INDUCTOR 0.45UH	
CJ902	1-216-295-00	CONDUCTOR, CHIP		FBO02	1-410-396-41	FERRITE BEAD INDUCTOR 0.45UH	
		<CONNECTOR>				<IC>	
CN802	*1-564-510-11	PLUG, CONNECTOR 7P		IC901	8-759-133-90	IC UPC339C	
CN805	1-695-915-11	TAB (CONTACT)		IC902	8-759-133-90	IC UPC339C	
CN827	*1-573-963-11	PIN, CONNECTOR (PC BOARD) 3P		IC903	8-759-711-28	IC NJM2058D	
CN851	*1-564-509-11	PLUG, CONNECTOR 6P		IC904	8-759-634-51	IC M5218AP	
CN881	*1-573-986-11	PIN, CONNECTOR (PC BOARD) 5P		IC905	8-759-929-65	IC LM7912CT	
CN882	*1-691-135-11	PIN, CONNECTOR (PC BOARD) 4P		IC906	8-759-701-79	IC NJM7812FA	
CN884	*1-573-964-11	PIN, CONNECTOR (PC BOARD) 6P				<COIL>	
CN885	*1-506-371-00	PIN, CONNECTOR 2P		L801	1-406-665-11	COIL, CHOKE 100UH	
CN886	*1-506-371-00	PIN, CONNECTOR 2P		L802	1-406-665-11	COIL, CHOKE 100UH	
CN904	*1-564-507-11	PLUG, CONNECTOR 4P		L803	1-422-613-11	COIL, AIR CORE	
		<DIODE>		L804	1-411-286-11	COIL, CHOKE 220UH	
D801	8-719-109-85	DIODE RD5.1ESB2		L901	1-408-416-00	INDUCTOR 39UH	
D802	8-719-404-46	DIODE MA110		L902	1-408-416-00	INDUCTOR 39UH	
D803	8-719-971-20	DIODE ERC38-06				<NEON LAMP>	
D804	8-719-908-03	DIODE GP08D		NL802	1-519-108-XX	LAMP, NEON	
D805	8-719-945-80	DIODE ERC06-15S				<TRANSISTOR>	
D806	8-719-911-19	DIODE ISS119-25		Q801	8-729-119-80	TRANSISTOR 2SC2688-LK	
D807	8-719-945-80	DIODE ERC06-15S		Q802	8-729-119-80	TRANSISTOR 2SC2688-LK	
D808	8-719-500-71	DIODE D8LC40F		Q803	8-729-122-12	TRANSISTOR 2SA1221-L	
D809	8-719-911-19	DIODE ISS119-25		Q806	8-729-805-07	TRANSISTOR 2SD1887-CA	
D810	8-719-945-80	DIODE ERC06-15S		Q807	8-729-120-28	TRANSISTOR 2SC1623-L5L6	
D811	8-719-920-67	DIODE ERC91-02		Q808	8-729-024-30	TRANSISTOR IRF1640LF	
D812	8-719-404-46	DIODE MA110		Q809	8-729-823-81	TRANSISTOR 2SC4632LS-CB7	
D814	8-719-920-67	DIODE ERC91-02		Q810	8-729-231-55	TRANSISTOR 2SC2878AB	
D816	8-719-404-46	DIODE MA110		Q811	8-729-823-81	TRANSISTOR 2SC4632LS-CB7	
D817	8-719-404-46	DIODE MA110		Q813	8-729-216-22	TRANSISTOR 2SA1162-G	
D818	8-719-404-46	DIODE MA110		Q901	8-729-120-28	TRANSISTOR 2SC1623-L5L6	
D819	8-719-105-82	DIODE RD5.1M-B2		Q902	8-729-140-93	TRANSISTOR 2SB733-34	
D901	8-719-404-46	DIODE MA110		Q903	8-729-140-96	TRANSISTOR 2SD774-34	
D902	8-719-404-46	DIODE MA110		Q904	8-729-120-28	TRANSISTOR 2SC1623-L5L6	
D904	8-719-404-46	DIODE MA110		Q905	8-729-120-28	TRANSISTOR 2SC1623-L5L6	
D905	8-719-404-46	DIODE MA110		Q906	8-729-120-28	TRANSISTOR 2SC1623-L5L6	
D907	8-719-404-46	DIODE MA110		Q907	8-729-231-55	TRANSISTOR 2SC2878AB	
D908	8-719-105-82	DIODE RD5.1M-B2		Q908	8-729-120-28	TRANSISTOR 2SC1623-L5L6	
D909	8-719-302-43	DIODE EL1Z		Q909	8-729-120-28	TRANSISTOR 2SC1623-L5L6	
D911	8-719-105-82	DIODE RD5.1M-B2		Q910	8-729-120-28	TRANSISTOR 2SC1623-L5L6	
D912	8-719-105-82	DIODE RD5.1M-B2		Q911	8-729-120-28	TRANSISTOR 2SC1623-L5L6	
D913	8-719-404-46	DIODE MA110		Q912	8-729-216-22	TRANSISTOR 2SA1162-G	
D914	8-719-404-46	DIODE MA110		Q913	8-729-900-36	TRANSISTOR DTC124ES	
D915	8-719-404-46	DIODE MA110		Q914	8-729-120-28	TRANSISTOR 2SC1623-L5L6	
D916	8-719-105-57	DIODE RD3.9M-B1		Q915	8-729-120-28	TRANSISTOR 2SC1623-L5L6	
D917	8-719-404-46	DIODE MA110				<RESISTOR>	
D918	8-719-404-46	DIODE MA110		R801	1-216-041-00	METAL GLAZE 470 5% 1/10W	
D919	8-719-106-81	DIODE RD13M-B3		R802	1-249-421-11	CARBON 2.2K 5% 1/4W	
D920	8-759-157-40	DIODE UPC574J		R804	1-249-425-11	CARBON 4.7K 5% 1/4W F	
D921	8-719-106-81	DIODE RD13M-B3		R805	1-216-435-11	METAL OXIDE 2.7K 5% 1W F	
D922	8-719-404-46	DIODE MA110		R806	1-249-431-11	CARBON 15K 5% 1/4W F	
D923	8-719-404-46	DIODE MA110		R807	1-260-325-11	CARBON 560 5% 1/2W	
D924	8-719-404-46	DIODE MA110		R808	1-260-325-11	CARBON 560 5% 1/2W F	
D925	8-719-105-45	DIODE RD3.3M-B1					
D926	8-719-404-46	DIODE MA110					
D927	8-719-105-73	DIODE RD4.7M-B2					

• The components identified by in this manual have been carefully factory-selected for each set in order to satisfy regulations regarding X-ray radiation. Should replacement be required, replace only with the value originally used.

The components identified by shading and mark Δ are critical for safety. Replace only with part number specified.

Les composants identifiés par une trame et une marque Δ sont critiques pour la sécurité. Ne les remplacer que par une pièce portant le numéro spécifié.



REF. NO.	PART NO.	DESCRIPTION	REMARK	REF. NO.	PART NO.	DESCRIPTION	REMARK
Δ R809		CARBON	1/4W F	R928	1-216-067-00	METAL GLAZE	5.6K 5% 1/10W
R810	1-249-427-11	CARBON	6.8K 5% 1/4W F	R929	1-216-041-00	METAL GLAZE	470 5% 1/10W
R811	1-216-097-00	METAL GLAZE	100K 5% 1/10W	R930	1-216-081-00	METAL GLAZE	22K 5% 1/10W
R812	1-216-395-00	METAL OXIDE	3.3 5% 3W F	R931	1-216-059-00	METAL GLAZE	2.7K 5% 1/10W
R813	1-216-484-00	METAL OXIDE	3.9K 5% 3W F	R932	1-216-059-00	METAL GLAZE	2.7K 5% 1/10W
R814	1-215-919-11	METAL OXIDE	2.2K 5% 3W F	R933	1-216-081-00	METAL GLAZE	22K 5% 1/10W
R816	1-216-051-00	METAL GLAZE	1.2K 5% 1/10W	R934	1-216-085-00	METAL GLAZE	33K 5% 1/10W
R817	1-216-395-00	METAL OXIDE	3.3 5% 3W F	R935	1-216-049-00	METAL GLAZE	1K 5% 1/10W
R818	1-249-405-11	CARBON	100 5% 1/4W F	R936	1-216-065-00	METAL GLAZE	4.7K 5% 1/10W
R819	1-216-083-00	METAL GLAZE	27K 5% 1/10W	R937	1-216-049-00	METAL GLAZE	1K 5% 1/10W
R820	1-215-905-11	METAL OXIDE	10 5% 3W F	R938	1-208-810-11	METAL CHIP	15K 0.50% 1/10W
R821	1-216-073-00	METAL GLAZE	10K 5% 1/10W	R939	1-216-073-00	METAL GLAZE	10K 5% 1/10W
R822	1-215-928-11	METAL OXIDE	68K 5% 3W F	R940	1-216-083-00	METAL GLAZE	27K 5% 1/10W
R823	1-216-047-00	METAL GLAZE	820 5% 1/10W	R941	1-216-091-00	METAL GLAZE	56K 5% 1/10W
R825	1-215-928-11	METAL OXIDE	68K 5% 3W F	R942	1-216-049-00	METAL GLAZE	1K 5% 1/10W
R826	1-216-033-00	METAL GLAZE	220 5% 1/10W	R943	1-249-377-11	CARBON	0.47 5% 1/4W F
R830	1-215-928-11	METAL OXIDE	68K 5% 3W F	R944	1-216-689-11	METAL GLAZE	39K 5% 1/10W
R831	1-215-919-11	METAL OXIDE	2.2K 5% 3W F	R945	1-216-077-00	METAL GLAZE	15K 5% 1/10W
R832	1-216-049-00	METAL GLAZE	1K 5% 1/10W	R946	1-216-073-00	METAL GLAZE	10K 5% 1/10W
R835	1-249-474-11	CARBON	1 5% 1/2W F	R947	1-216-025-00	METAL GLAZE	100 5% 1/10W
R836	1-202-818-00	SOLID	1K 20% 1/2W	R948	1-216-051-00	METAL GLAZE	1.2K 5% 1/10W
R837	1-215-870-11	METAL OXIDE	1.5K 5% 1W F	R950	1-216-049-00	METAL GLAZE	1K 5% 1/10W
R838	1-247-807-31	CARBON	100 5% 1/4W	R952	1-216-049-00	METAL GLAZE	1K 5% 1/10W
R839	1-249-429-11	CARBON	10K 5% 1/4W F	R954	1-214-777-00	METAL	100K 1% 1/4W
R841	1-216-491-11	METAL OXIDE	56K 5% 3W F	R955	1-214-769-00	METAL	47K 1% 1/4W
R843	1-202-549-00	SOLID	100 20% 1/2W	R956	1-208-806-11	METAL CHIP	10K 0.50% 1/10W
R844	1-216-491-11	METAL OXIDE	56K 5% 3W F	R957	1-218-754-11	METAL CHIP	120K 0.50% 1/10W
R846	1-202-838-00	SOLID	100K 20% 1/2W	R958	1-218-756-11	METAL CHIP	150K 0.50% 1/10W
R847	1-216-073-00	METAL GLAZE	10K 5% 1/10W	R959	1-214-757-00	METAL	15K 1% 1/4W
R849	1-247-863-91	CARBON	22K 5% 1/4W	R960	1-216-077-00	METAL GLAZE	15K 5% 1/10W
R850	1-216-081-00	METAL GLAZE	22K 5% 1/10W	R962	1-208-806-11	METAL CHIP	10K 0.50% 1/10W
R851	1-216-667-11	METAL CHIP	4.7K 0.50% 1/10W	R963	1-214-749-00	METAL	6.8K 1% 1/4W
R852	1-208-806-11	METAL CHIP	10K 0.50% 1/10W	R964	1-214-757-00	METAL	15K 1% 1/4W
R854	1-249-381-11	CARBON	1 5% 1/4W F	R965	1-216-097-00	METAL GLAZE	100K 5% 1/10W
R855	1-208-822-11	METAL CHIP	47K 0.50% 1/10W	R966	1-214-757-00	METAL	15K 1% 1/4W
R856	1-208-822-11	METAL CHIP	47K 0.50% 1/10W	R967	1-216-025-00	METAL GLAZE	100 5% 1/10W
R857	1-218-755-11	METAL CHIP	130K 0.50% 1/10W	R968	1-214-751-00	METAL	8.2K 1% 1/4W
R858	1-216-676-11	METAL CHIP	11K 0.50% 1/10W	R969	1-214-731-00	METAL	1.2K 1% 1/4W
R901	1-216-065-00	METAL GLAZE	4.7K 5% 1/10W	R970	1-214-757-00	METAL	15K 1% 1/4W
R902	1-216-065-00	METAL GLAZE	4.7K 5% 1/10W	R971	1-216-121-00	METAL GLAZE	1M 5% 1/10W
R903	1-216-085-00	METAL GLAZE	33K 5% 1/10W	R972	1-216-699-11	METAL CHIP	100K 0.50% 1/10W
R904	1-216-057-00	METAL GLAZE	2.2K 5% 1/10W	R973	1-216-081-00	METAL GLAZE	22K 5% 1/10W
R905	1-247-739-11	CARBON	100 5% 1/2W F	R974	1-216-699-11	METAL CHIP	100K 0.50% 1/10W
R906	1-247-739-11	CARBON	100 5% 1/2W F	R975	1-216-043-91	METAL GLAZE	560 5% 1/10W
R907	1-216-091-00	METAL GLAZE	56K 5% 1/10W	R976	1-216-041-00	METAL GLAZE	470 5% 1/10W
R908	1-216-085-00	METAL GLAZE	33K 5% 1/10W	R977	1-216-075-00	METAL GLAZE	12K 5% 1/10W
R909	1-216-113-00	METAL GLAZE	470K 5% 1/10W	R978	1-216-057-00	METAL GLAZE	2.2K 5% 1/10W
R910	1-216-059-00	METAL GLAZE	2.7K 5% 1/10W	R979	1-216-075-00	METAL GLAZE	12K 5% 1/10W
R911	1-216-059-00	METAL GLAZE	2.7K 5% 1/10W	R980	1-216-081-00	METAL GLAZE	22K 5% 1/10W
R912	1-216-073-00	METAL GLAZE	10K 5% 1/10W	R981	1-216-073-00	METAL GLAZE	10K 5% 1/10W
R913	1-216-077-00	METAL GLAZE	15K 5% 1/10W	R982	1-216-671-11	METAL CHIP	6.8K 0.50% 1/10W
R914	1-216-049-00	METAL GLAZE	1K 5% 1/10W	Δ R983		METAL GLAZE	1/10W
R915	1-216-091-00	METAL GLAZE	56K 5% 1/10W	R984	1-216-083-00	METAL GLAZE	27K 5% 1/10W
R916	1-216-065-00	METAL GLAZE	4.7K 5% 1/10W	R985	1-208-812-11	METAL CHIP	18K 0.50% 1/10W
R917	1-216-057-00	METAL GLAZE	2.2K 5% 1/10W	R986	1-216-049-00	METAL GLAZE	1K 5% 1/10W
R918	1-216-073-00	METAL GLAZE	10K 5% 1/10W	R987	1-216-059-00	METAL GLAZE	2.7K 5% 1/10W
R919	1-216-077-00	METAL GLAZE	15K 5% 1/10W	Δ R988		METAL GLAZE	1/10W
R920	1-216-113-00	METAL GLAZE	470K 5% 1/10W	R989	1-216-462-00	METAL OXIDE	8.2K 5% 2W F
R921	1-216-059-00	METAL GLAZE	2.7K 5% 1/10W	R990	1-215-897-11	METAL OXIDE	6.8K 5% 2W F
R922	1-216-073-00	METAL GLAZE	10K 5% 1/10W	R991	1-208-803-11	METAL CHIP	7.5K 0.50% 1/10W
R923	1-216-077-00	METAL GLAZE	15K 5% 1/10W	R992	1-249-431-11	CARBON	15K 5% 1/4W
R924	1-216-067-00	METAL GLAZE	5.6K 5% 1/10W	R993	1-249-431-11	CARBON	15K 5% 1/4W
R926	1-216-049-00	METAL GLAZE	1K 5% 1/10W	R994	1-247-807-31	CARBON	100 5% 1/4W
R927	1-249-377-11	CARBON	0.47 5% 1/4W F				

• The components identified by Δ in this manual have been carefully factory-selected for each set in order to satisfy regulations regarding X-ray radiation. Should replacement be required, replace only with the value originally used.

- M BOARD -

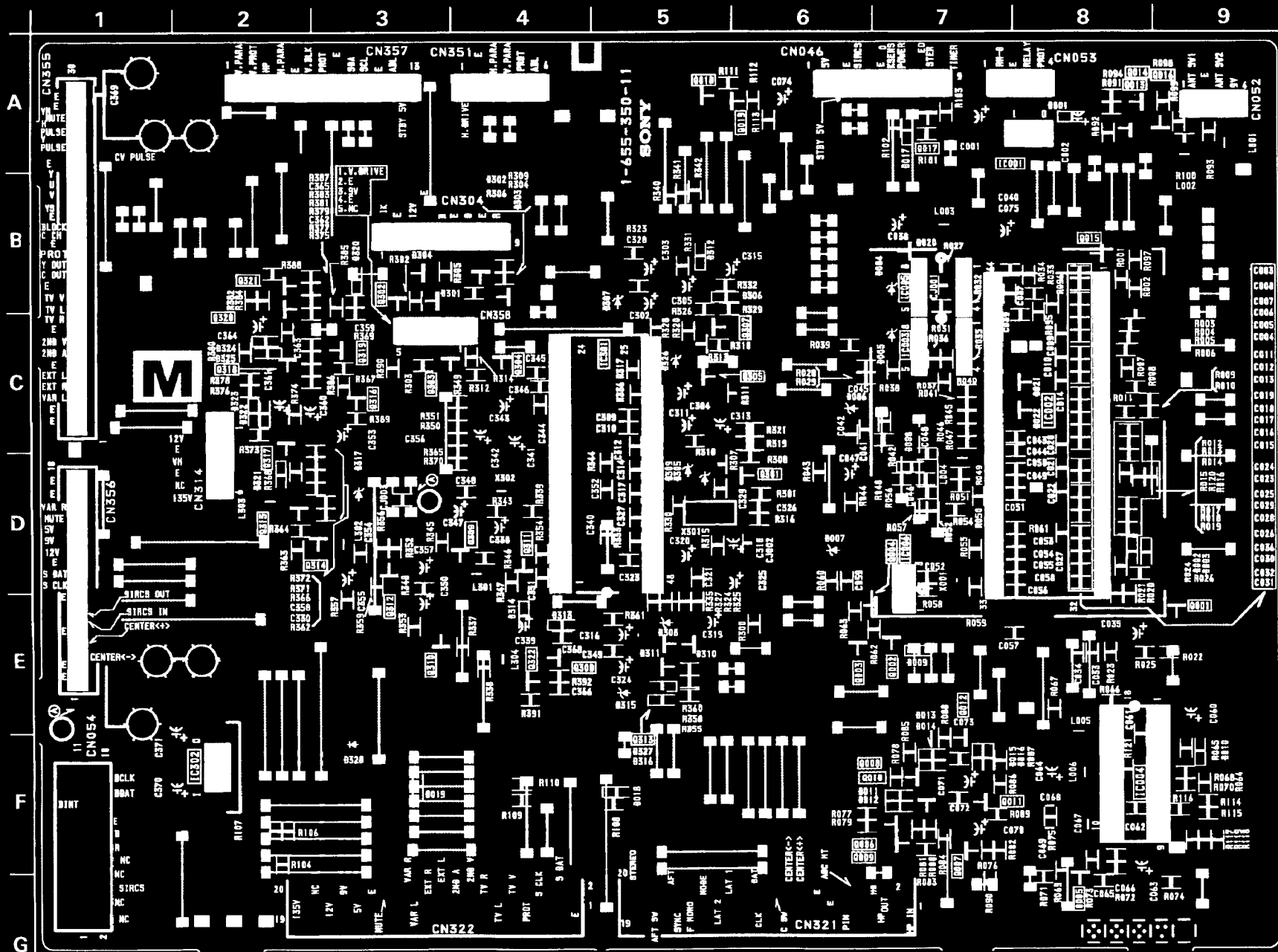

M BOARD

IC		DIODE	
IC001	A-8	D001	A-8
IC002	C-8	D002	D-8
IC003	C-7	D003	D-9
IC004	F-8	D004	B-7
IC005	B-7	D005	C-7
IC006	E-7	D006	C-6
IC301	C-5	D007	D-6
IC302	F-2	D008	D-7
TRANSISTOR			
Q001	E-9	D009	E-7
Q002	E-7	D010	F-9
Q003	E-6	D011	F-7
Q004	E-7	D012	F-7
Q005	G-8	D013	F-7
Q006	F-7	D014	F-7
Q007	F-7	D015	F-7
Q008	F-7	D016	F-7
Q009	F-7	D017	A-7
Q010	F-7	D018	F-5
Q011	F-7	D019	F-3
Q012	F-7	D020	B-7
Q017	A-7	D305	D-5
Q018	A-5	D307	C-5
Q019	A-6	D308	E-5
Q301	D-6	D309	D-5
Q302	C-3	D310	E-5
Q303	C-4	D311	E-5
Q304	C-4	D312	B-5
Q305	C-5	D313	E-4
Q307	C-5	D314	E-4
Q308	E-4	D315	E-5
Q309	D-4	D316	E-5
Q310	E-4	D317	D-3
Q311	D-4	D320	B-3
Q312	E-3	D321	D-2
Q313	E-5	D322	C-2
Q314	D-3	D323	C-2
Q315	D-3	D324	C-2
Q316	C-3	D325	C-2
Q317	D-2	D326	C-5
Q318	C-2	D327	E-5
Q319	C-3	D328	F-3
Q320	C-2		
Q321	B-2		
Q322	E-4		

P [PICTURE IN PICTURE]

P BOARD

IC	
IC3200	E-1
IC3201	B-2
IC3202	C-3
IC3203	B-3
IC3204	B-3
IC3205	B-1
TRANSISTOR	
Q3201	F-2
Q3202	F-4
Q3203	C-4
Q3204	D-4
Q3206	D-4
Q3207	D-4
Q3208	C-3
Q3209	C-4
Q3210	A-2
DIODE	
D3202	B-1
D3203	D-2
D3208	D-2
D3209	D-3

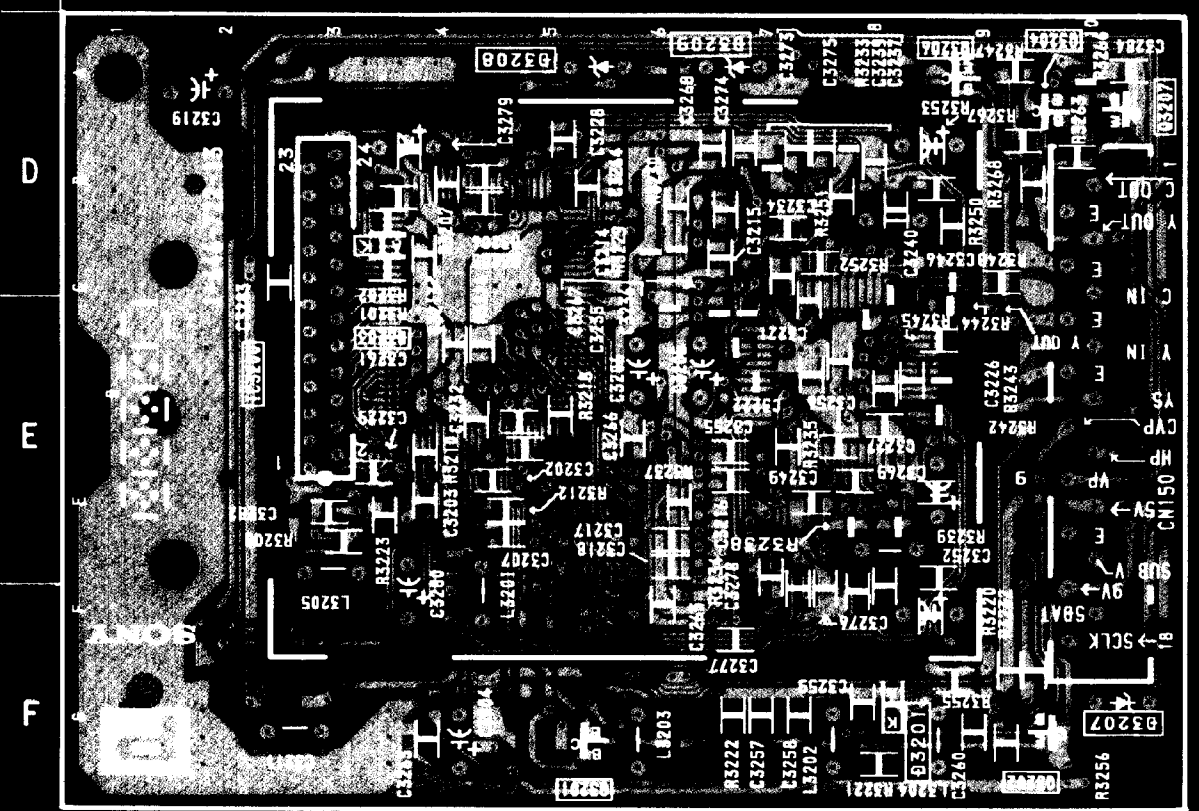
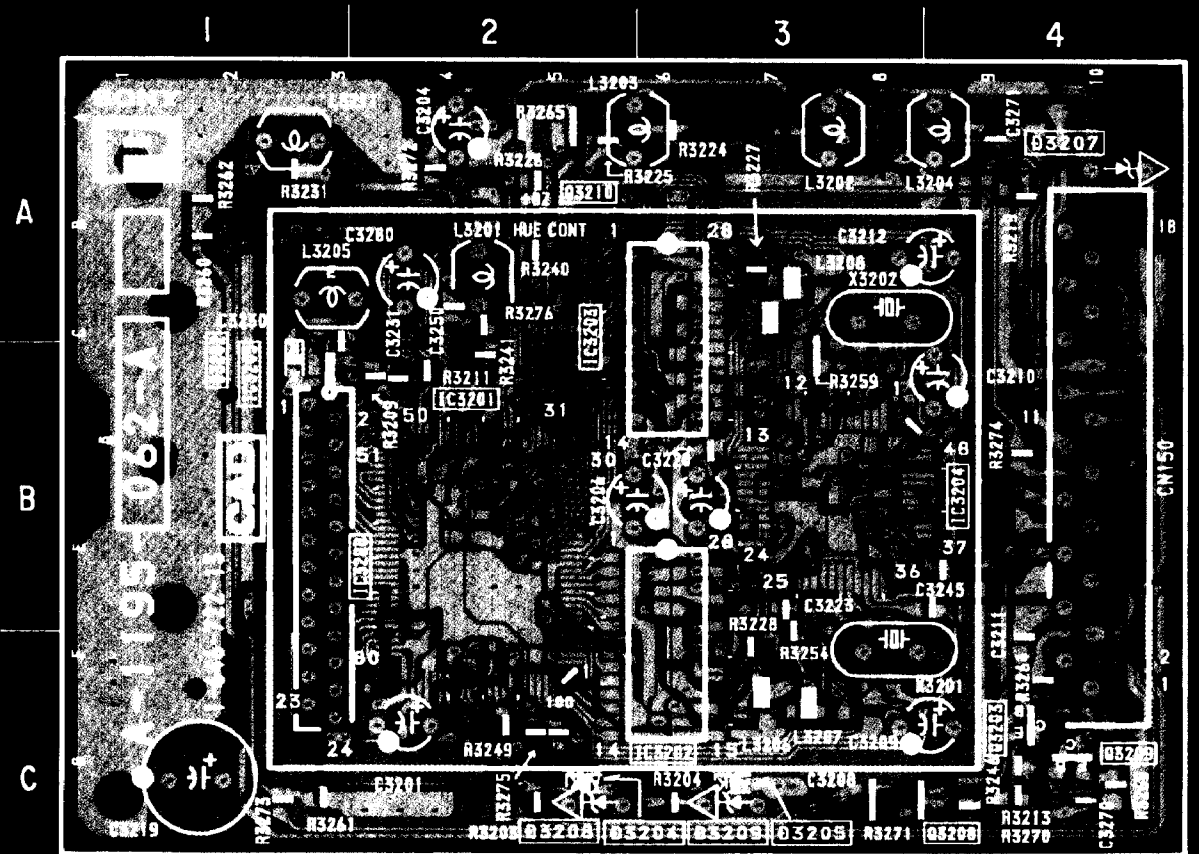

Note :
 : Pattern of the rear side.

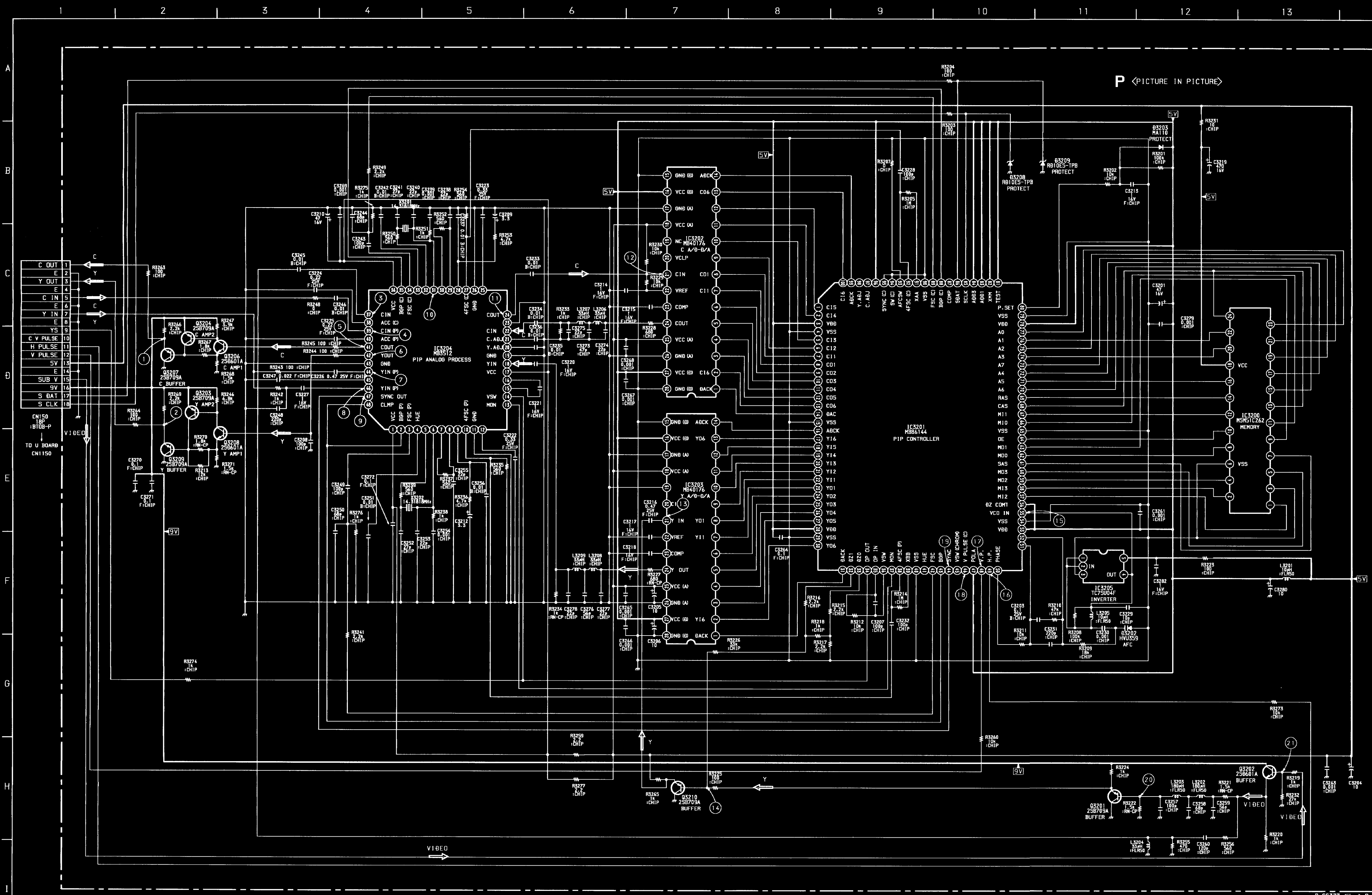

P BOARD IC VOLTAGE LIST ALL VOLTAGES ARE IN V

IC3200	1 *	6 GND	11 2.3	16 2.1	21 2.5
	2 *	7 1.5	12 2.4	17 2.5	22 2.5
	3 GND	8 *	13 *	18 5.0	23 2.3
	4 *	9 2.0	14 3.2	19 2.5	24 4.0
	5 *	10 1.9	15 2.7	20 2.5	
IC3201	1 3.1	21 2.0	41 4.9	61 *	81 6.0
	2 3.1	22 2.3	42 2.5	62 *	82 6.0
	3 5.0	23 5.0	43 4.7	63 *	83 6.0
	4 GND	24 5.0	44 3.7	64 *	84 6.0
	5 0	25 0	45 NC	65 GND	85 4.6
	6 2.9	26 0	46 0	66 2.3	86 4.6
	7 2.8	27 5.0	47 5.0	67 6.0	87 6.0
	8 0	28 5.0	48 0.2	68 4.0	88 4.7
	9 0	29 GND	49 0.8	69 3.2	89 2.5
	10 0.2	30 0	50 2.5	70 2.7	90 GND
	11 0.2	31 2.9	51 2.5	71 2.1	91 2.5
	12 0.2	32 2.9	52 3.4	72 2.5	92 2.4
13 4.9	33 2.2	53 6.0	73 2.5	93 GND	
14 2.6	34 4.9	54 GND	74 2.5	94 GND	
15 GND	35 5.0	55 2.5	75 2.5	95 GND	
16 2.7	36 5.0	56 5.0	76 2.5	96 5.0	
17 0	37 0.2	57 *	77 2.3	97 NC	
18 2.9	38 2.4	58 *	78 5.0	98 NC	
19 0.7	39 2.5	59 *	79 GND	99 2.7	
20 1.9	40 GND	60 *	80 4.9	100 0.8	
IC3202	1 2.6	7 0	13 0.8	19 NC	25 6.0
	2 4.9	8 2.8	14 2.7	20 NC	26 GND
	3 0.2	9 2.9	15 GND	21 4.5	27 6.0
	4 0.2	10 0	16 5.0	22 4.1	28 GND
	5 0.2	11 3.1	17 GND	23 2.8	
6 0	12 3.1	18 5.0	24 4.9		
IC3203	1 2.9	7 5.0	13 0	19 GND	25 5.0
	2 0	8 2.3	14 2.7	20 NC	26 GND
	3 5.0	9 2.0	15 GND	21 4.5	27 5.0
	4 0	10 1.9	16 5.0	22 4.1	28 GND
	5 0	11 0.7	17 GND	23 2.8	
6 5.0	12 2.9	18 5.0	24 3.8		
IC3204	1 5.0	6 3.2	11 GND	16 2.4	21 3.6
	2 4.7	7 2.6	12 0.2	17 5.0	22 2.9
	3 3.7	8 2.5	13 0.2	18 2.9	23 GND
	4 3.3	9 2.8	14 4.9	19 GND	24 1.8
	5 3.4	10 2.5	15 2.7	20 3.6	25 0
IC3204	26 GND	31 0	36 5.0	41 2.0	46 2.9
	27 2.5	32 3.4	37 1.5	42 1.6	47 3.7
	28 0	33 3.3	38 2.8	43 GND	48 4.7
	29 0	34 3.7	39 1.5	44 2.8	
	30 2.5	35 4.7	40 2.9	45 2.7	
IC3205	1 2.5	2 2.5	3 GND	4 2.5	5 4.9

P BOARD WAVEFORMS

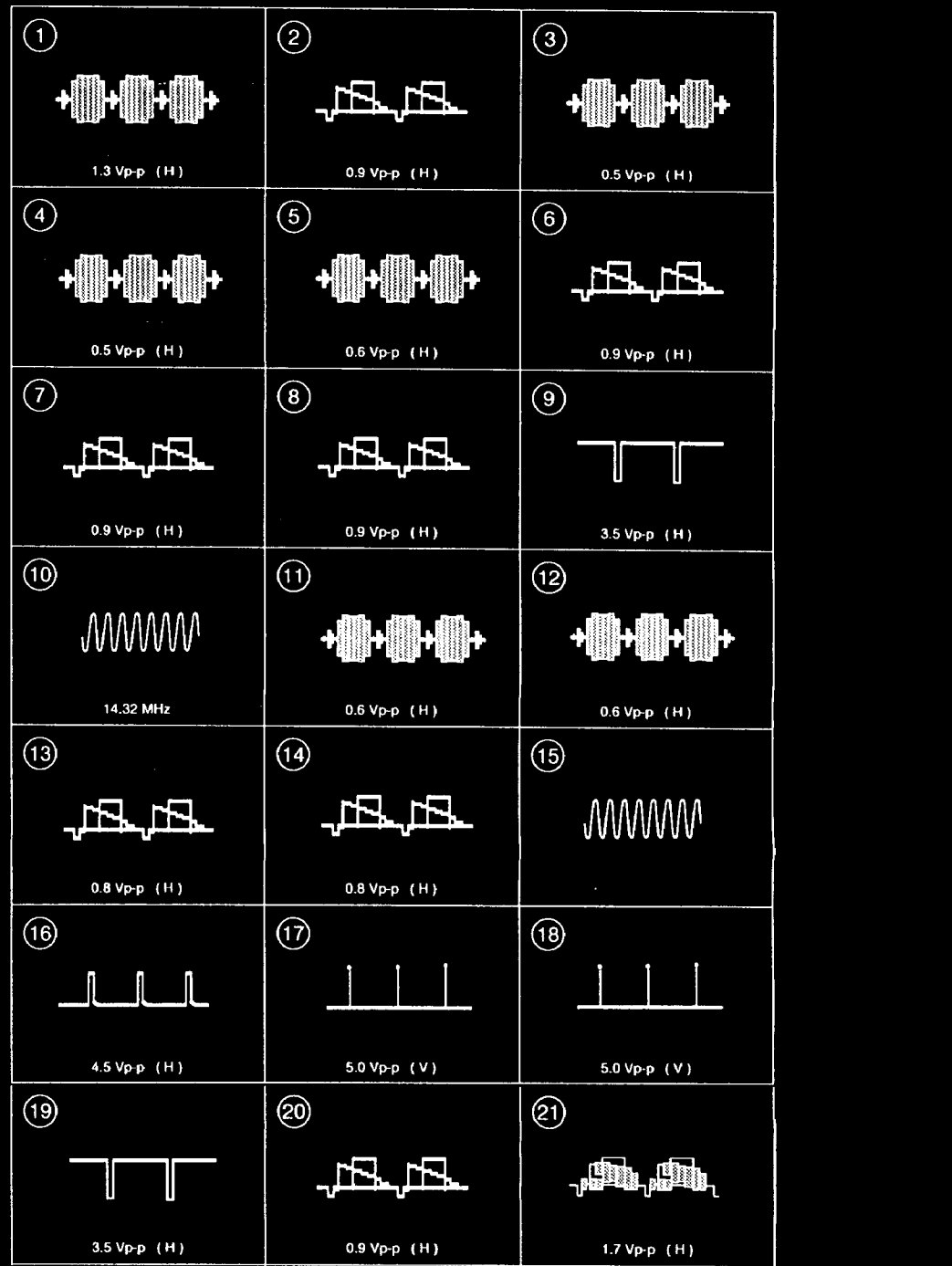

P BOARD TRANSISTOR VOLTAGE LIST

	E	C	B
Q3201	2.6	GND	1.9
Q3202	3.8	9.0	4.4
Q3203	9.0	1.6	8.5
Q3204	9.0	2.6	8.5
Q3206	1.3	8.5	1.9
Q3207	3.3	GND	2.6
Q3208	0.9	8.5	1.6
Q3209	2.3	GND	1.6
Q3210	3.2	GND	2.6

P BOARD IC3202, IC3203 MB40176

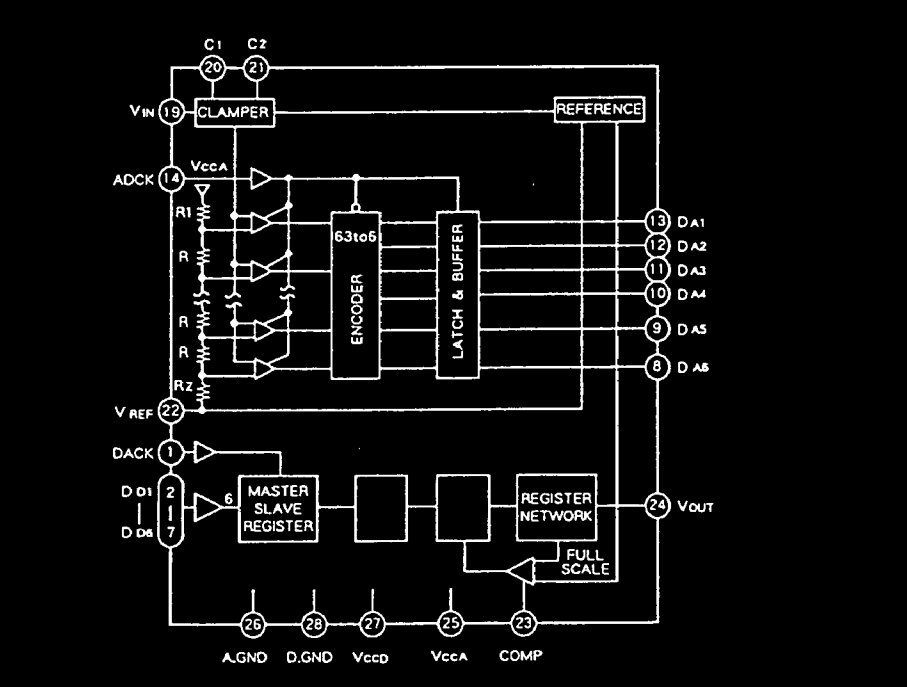

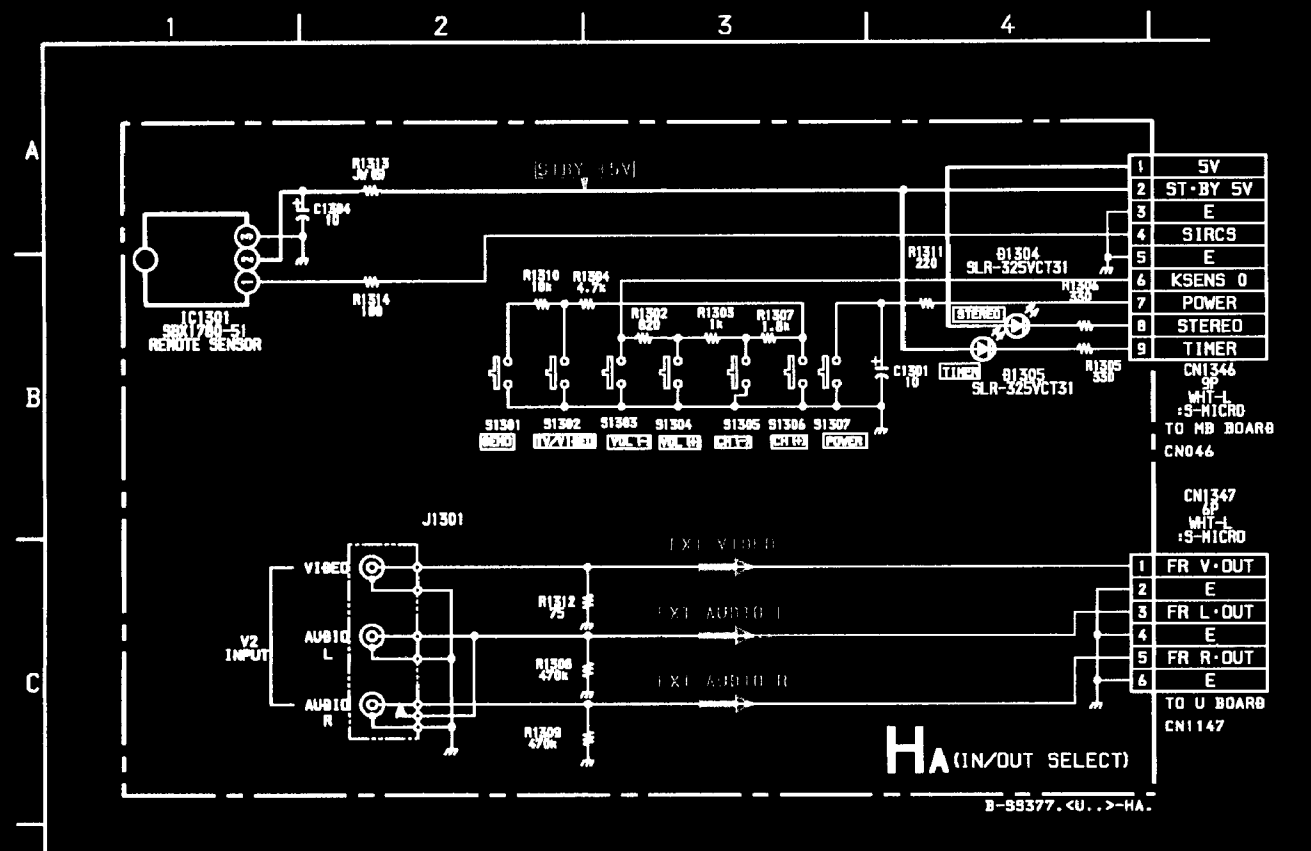

HA BOARD IC VOLTAGE LIST

IC101	1 5.1	2 5.1	3 GND
-------	-------	-------	-------

ALL VOLTAGES ARE IN V

E BOARD IC VOLTAGE LIST ALL VOLTAGES ARE IN V

IC901	1 -6.3	4 3.9	7 4.6	10 4.0	13 -11.6
	2 6.3	5 7.7	8 2.6	11 0	14 2.0
	3 12.0	6 7.7	9 2.8	12 -12.0	
IC902	1 0.2	4 6.3	7 0	10 4.0	13 0.2
	2 0	5 4.8	8 5.2	11 0	14 0
	3 12.0	6 6.2	9 5.0	12 GND	
IC903	1 3.9	4 11.6	7 7.6	10 7.6	13 11.2
	2 3.9	5 7.6	8 3.9	11 -11.1	14 11.2
	3 3.9	6 7.6	9 7.6	12 0.4	
IC904	1 8.9	3 8.9	5 GND	7 2.2	
	2 8.9	4 -12.0	6 0.2	8 12.0	
IC905	1 -12.0	2 -15.0	3 GND		
IC906	1 12.0	2 15.0	3 GND		

E BOARD TRANSISTOR VOLTAGE LIST

	E	C	B
Q801	GND	106.7	-0.3
Q802	2.1	131.7	2.5
Q803	132.3	106.8	131.7
Q806	51.9	136.6	51.9
Q807	2.7	11.6	3.3
Q809	11.9	354.0	12.3
Q810	2.1	11.7	2.6
Q811	GND	642.0	0
Q813	12.3	0	12.3
Q901	GND	3.9	0.3
Q902	1.9	-12.0	2.0
Q903	1.9	12.0	2.0
Q904	GND	0.6	0.6
Q905	GND	7.7	0.2
Q906	GND	2.6	0.2
Q907	GND	0.6	0.6
Q908	GND	2.6	0.2
Q909	0.2	2.2	-2.1
Q910	GND	0	0.7
Q911	GND	0	0.7
Q912	10.7	GND	10.1
Q913	GND	3.4	-0.3
Q914	GND	2.6	-0.6
Q915	0	12.0	0
<hr/>			
	S	D	G
Q808	0	51.9	1.9

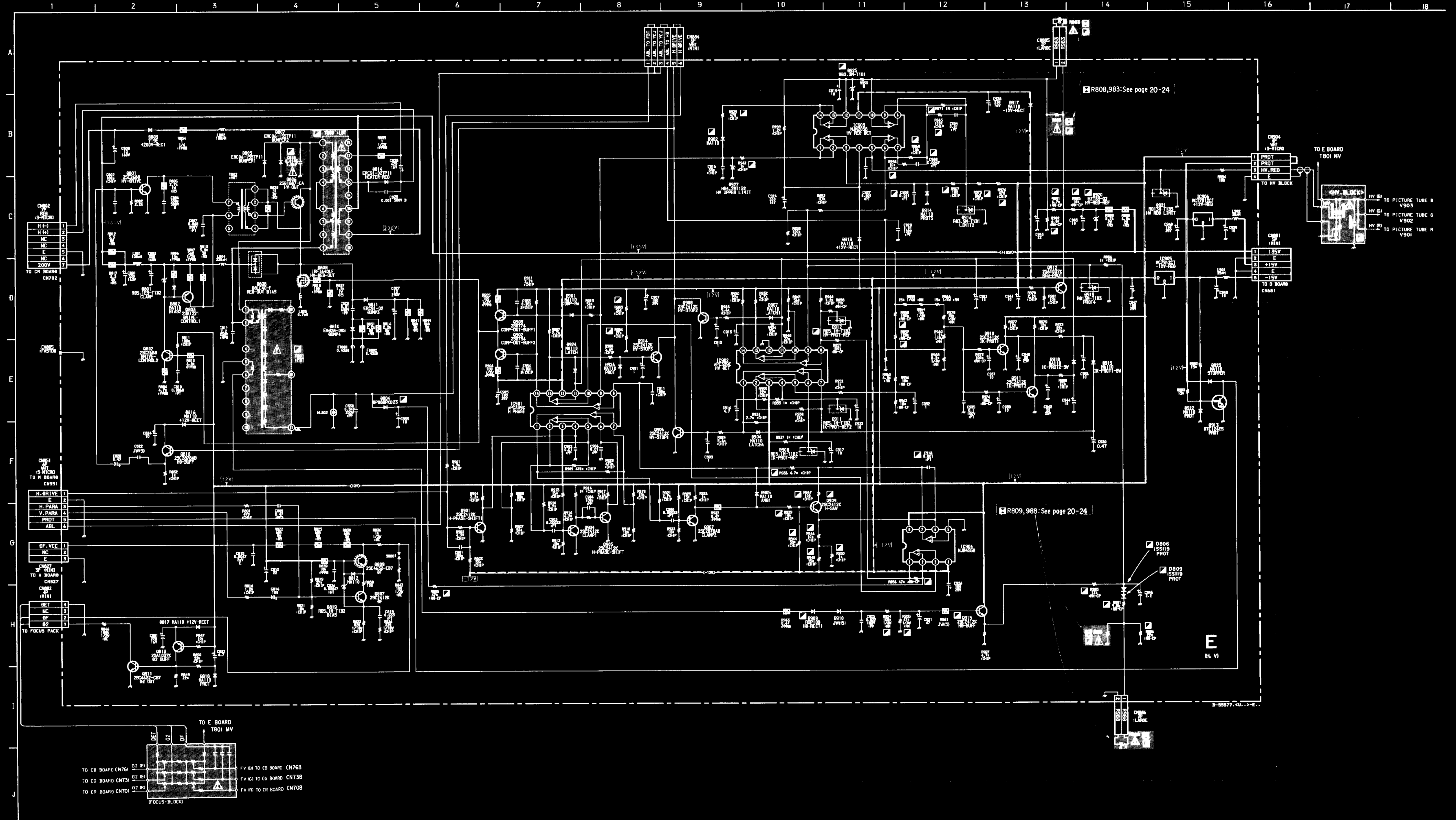

E [H. V] **HA** [IN/OUT SELECT]

E BOARD

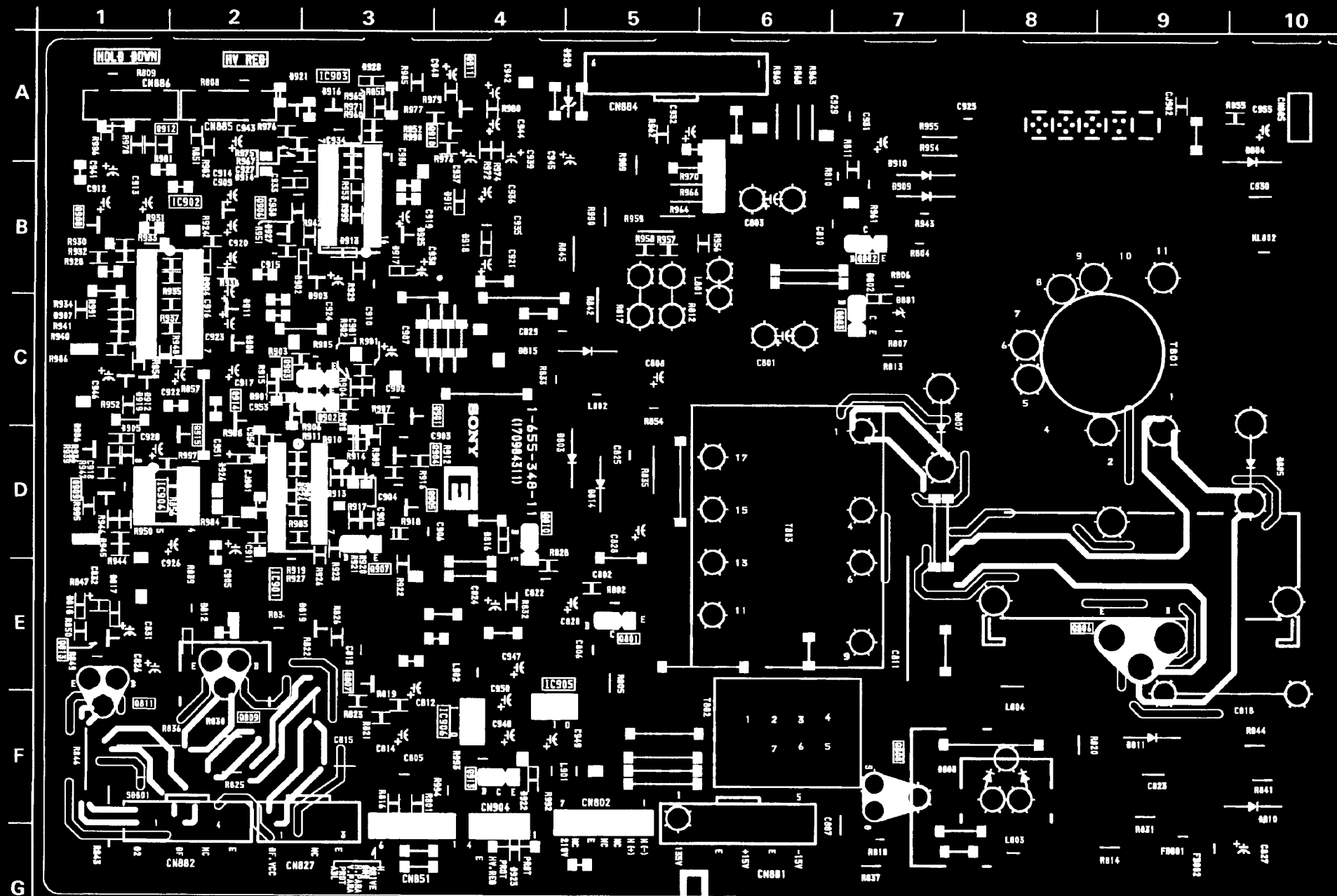

E BOARD

IC		D803	D-5
IC901	D-3	D804	B-10
IC902	B-2	D805	D-10
IC903	B-3	D806	
IC904	D-2	D807	D-7
IC905	F-4	D808	F-8
IC906	F-4	D809	
TRANSISTOR		D810	F-10
Q801	E-5	D811	F-9
Q802	B-7	D812	E-2
Q803	C-7	D814	D-5
Q806	E-9	D816	D-4
Q807	F-3	D817	E-1
Q808	F-7	D818	E-1
Q809	F-2	D819	E-3
Q810	D-4	D901	C-2
Q811	F-1	D902	B-3
Q813	E-1	D904	B-2
Q901	D-3	D905	D-1
Q902	C-3	D907	C-1
Q903	C-3	D908	C-2
Q904	D-3	D909	B-7
Q905	D-3	D911	C-2
Q906	B-2	D912	C-1
Q907	D-3	D913	B-3
Q908	B-1	D914	B-3
Q909	D-1	D915	B-4
Q910	A-4	D916	A-3
Q911	A-4	D917	B-3
Q912	A-2	D918	B-4
Q913	F-4	D919	C-1
Q914	D-2	D920	A-5
Q915	D-2	D921	A-3
DIODE		D922	F-4
D801	C-7	D923	F-4
D802	C-7	D924	D-3
		D925	B-3
		D926	D-2
		D927	B-2

HA BOARD

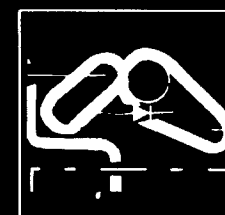
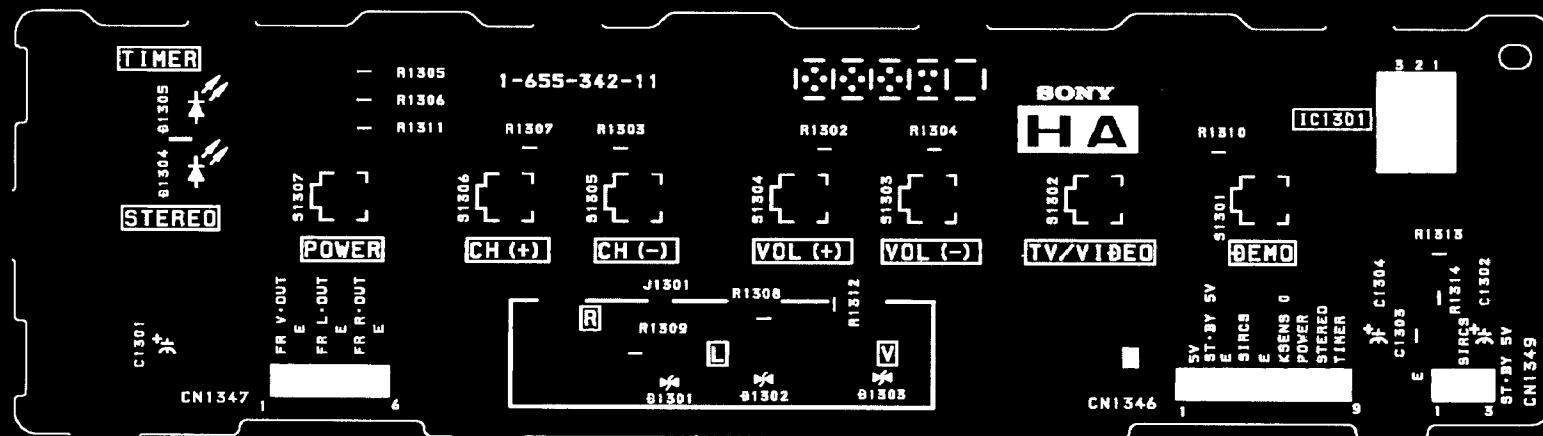

NOTE:

The circuit indicated as left contains high voltage of over 600 Vp-p. Care must be paid to prevent an electric shock in inspection or repairing.

G [POWER SUPPLY]

- G BOARD -

G BOARD

IC	D657	F-5
	D658	F-5
IC651	D-5	E-5
IC652	D-6	E-5
TRANSISTOR	D660	E-5
	D661	E-5
	D662	E-5
Q601	C-1	D-6
Q602	D-1	E-2
Q651	D-6	C-4
Q652	D-4	C-8
Q653	D-4	E-8
Q654	E-7	C-7
Q655	C-6	E-9
Q656	D-7	D-7
Q657	D-7	D-9
Q658	D-8	D-8
Q659	C-7	C-7
Q660	E-9	D-7
Q661	E-8	C-8
Q662	C-7	C-6
Q663	E-9	C-5
DIODE	D679	C-5
	D680	C-5
D601	C-3	C-5
D604	C-2	C-5
D605	C-2	C-5
D606	D-2	C-4
D607	D-2	D-4
D608	C-2	E-8
D609	C-2	D-5
D610	D-2	D-9
D611	D-2	E-8
D651	F-2	D-3
D655	F-6	
D656	F-5	

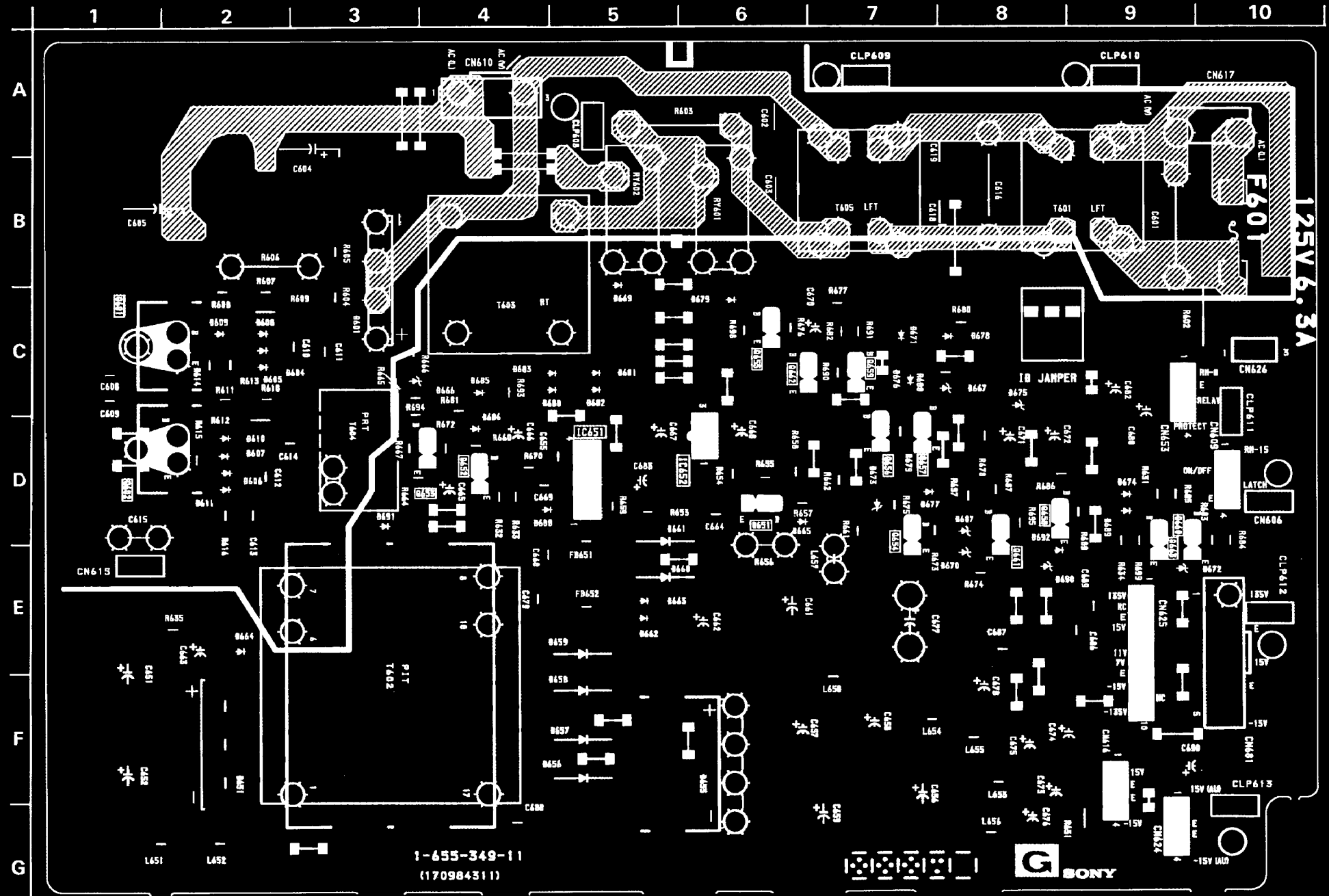

1-655-349-11
(170984311)



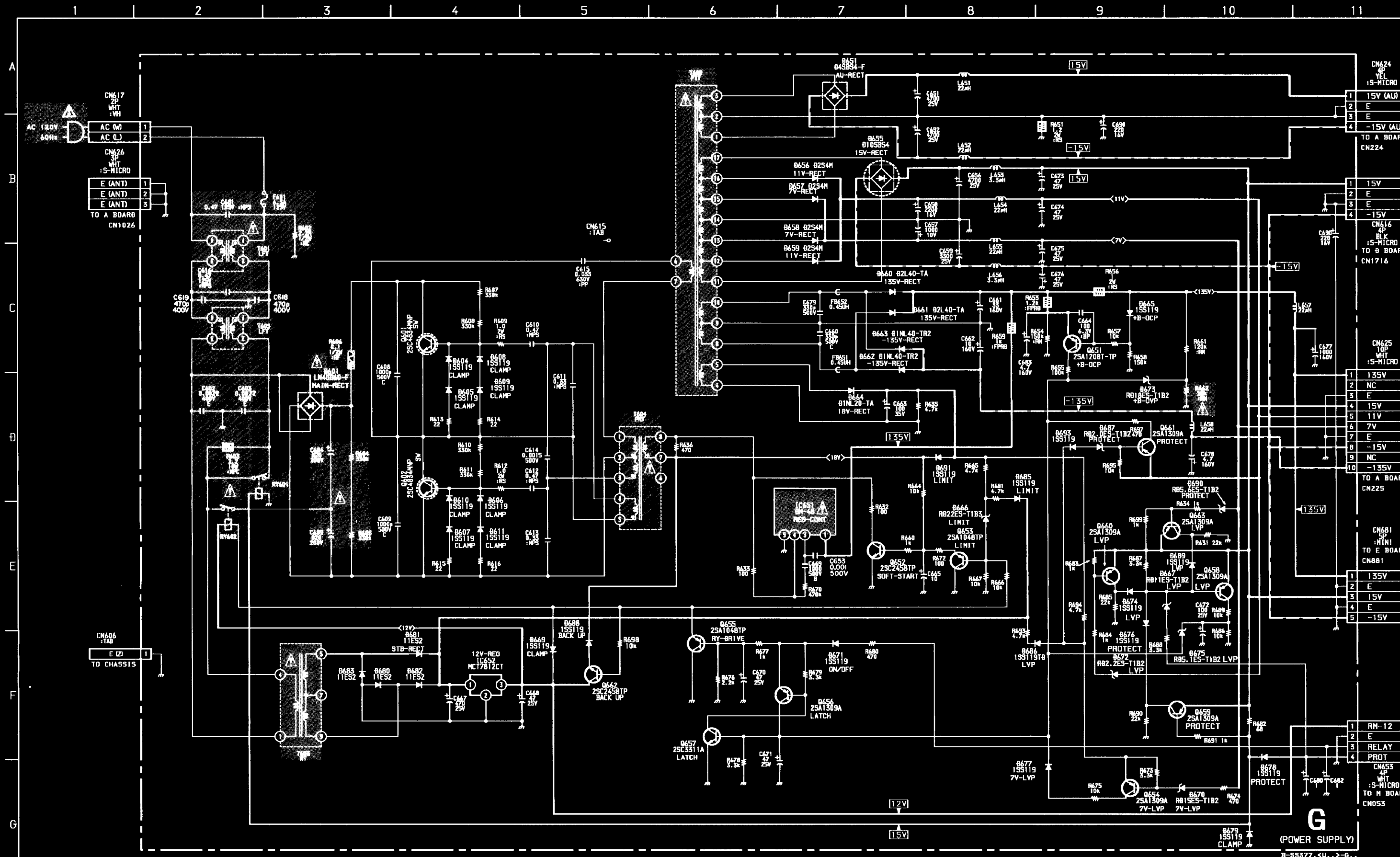

G BOARD IC VOLTAGE LIST ALL VOLTAGES ARE IN V

IC651	1 135.4	3 2.6	4 8.9	5 GND
IC652	1 22.0	2 GND	3 12.0	

G BOARD TRANSISTOR VOLTAGE LIST

	E	C	B
Q601	-1.8	0	-3.9
Q602	-118.5	-1.8	-120.3
Q651	135.5	0.2	135.4
Q652	13.0	GND	15.1
Q653	GND	15.1	0
Q654	15.7	-2.0	15.7
Q655	GND	0.2	0.8
Q656	2.7	0.2	2.7
Q657	GND	2.7	0.2
Q658	15.0	8.2	14.8
Q659	15.0	15.3	14.6
Q660	15.0	15.3	14.6
Q661	11.0	0.2	11.5
Q662	12.0	12.1	11.4
Q663	15.0	15.3	14.6

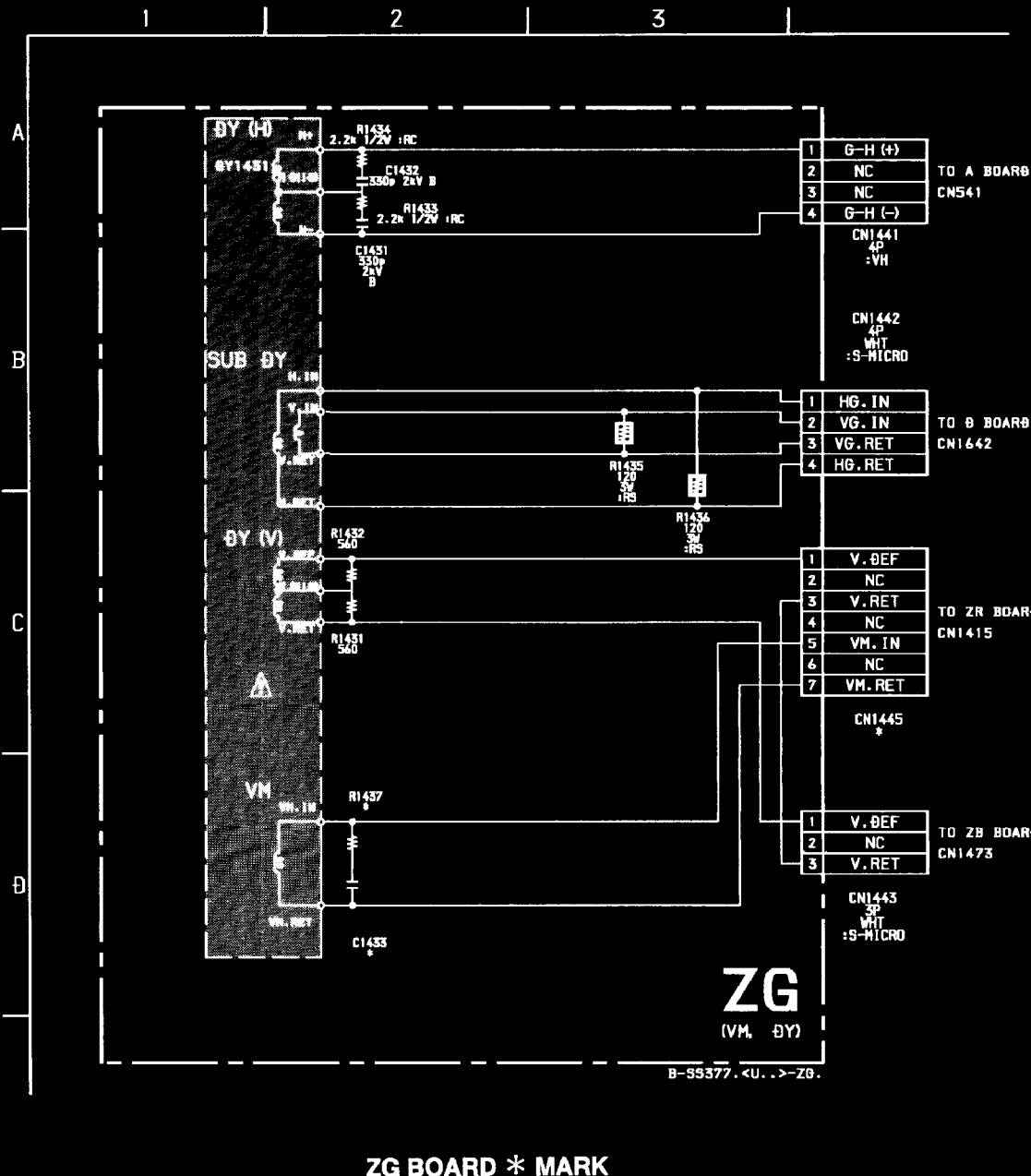
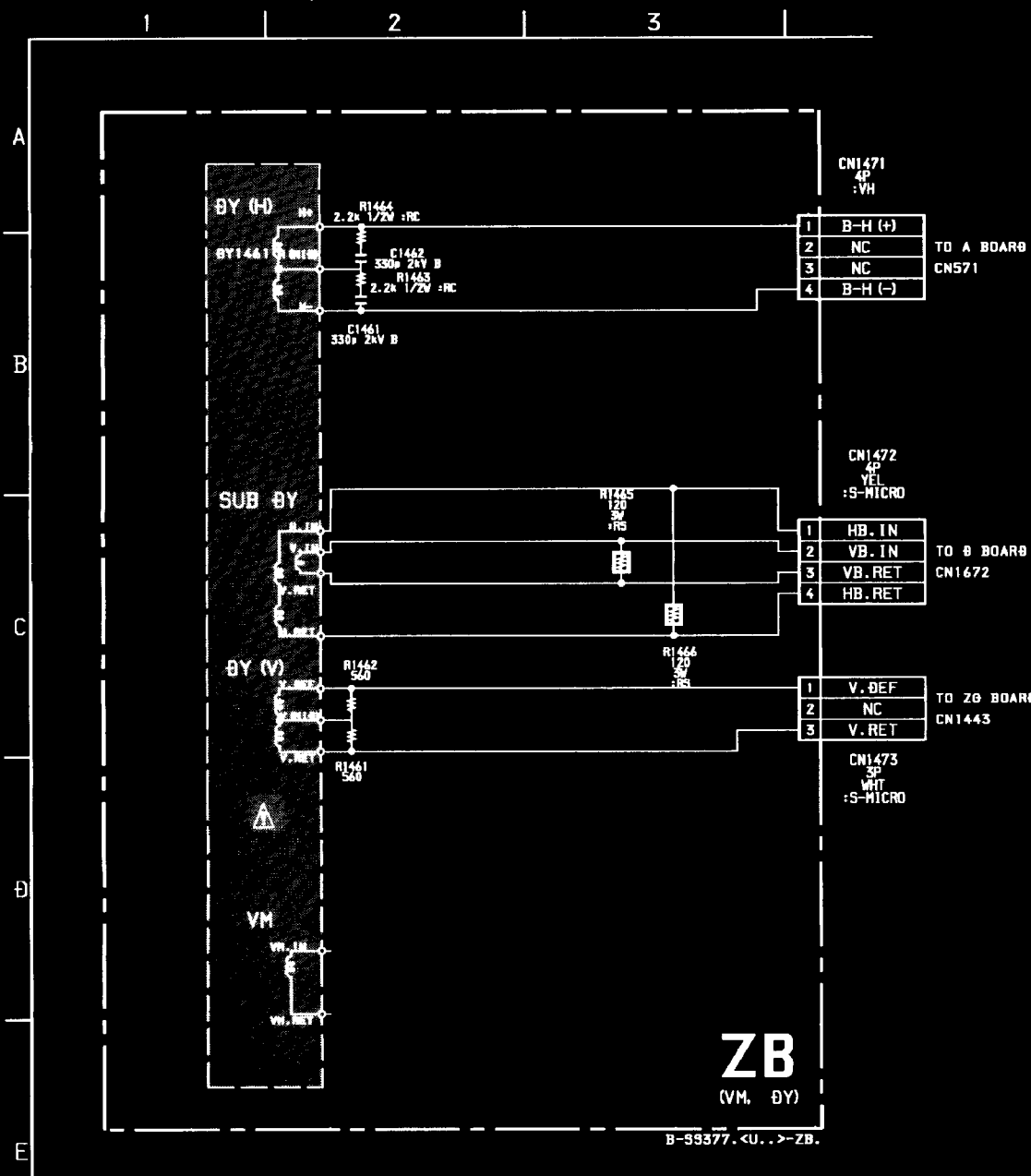

ZG BOARD * MARK

Ref.No.	KP-41T15(U/C)	KP-46S15(U/C)	KP-53S15(U/C)
C1433	100p	-	-
CN1445	7P	3P	3P
R1437	1k	-	-

— : NOT MOUNT

ZR BOARD * MARK

Ref.No.	KP-41T15(U/C)	KP-46S15(U/C)	KP-53S15(U/C)
C1403	220p	-	-
C1404	33 160V	-	-
C1405	100 25V	-	-
C1406	0.1	-	-
C1407	100 25V	-	-
C1408	0.0047	-	-
C1409	2.2 160V	-	-
C1410	0.0047	-	-
C1411	0.001	-	-
C1412	0.001	-	-
C1413	0.0047	-	-
C1414	330 16V	-	-
C1415	10p	-	-
C1416	100p	-	-
CN1414	6P	-	-
CN1415	7P	3P	3P
D1401	RD39ES-T1B	-	-
D1402	RD39ES-T1B	-	-
L1401	JW 5MM	-	-
Q1401	2SC4793	-	-
Q1402	2SA1837	-	-
Q1403	2SD774-T-4	-	-
R1405	1k	-	-
R1406	560 3W	-	-
R1407	39	-	-
R1408	1.8	-	-
R1409	1.8	-	-
R1410	39 1/2W	-	-
R1411	1k	-	-
R1412	560	-	-
R1413	18k	-	-
R1414	18k	-	-
R1415	560	-	-
R1416	120 2W	-	-
R1418	0.47	-	-
R1419	220	-	-
R1421	1k	-	-

ZR BOARD TRANSISTOR VOLTAGE LIST

	E	C	B
Q1401	0	-0.5	0
Q1402	-1.0	-0.5	-0.9
Q1403	4.8	12.0	5.4

ALL VOLTAGES ARE IN V

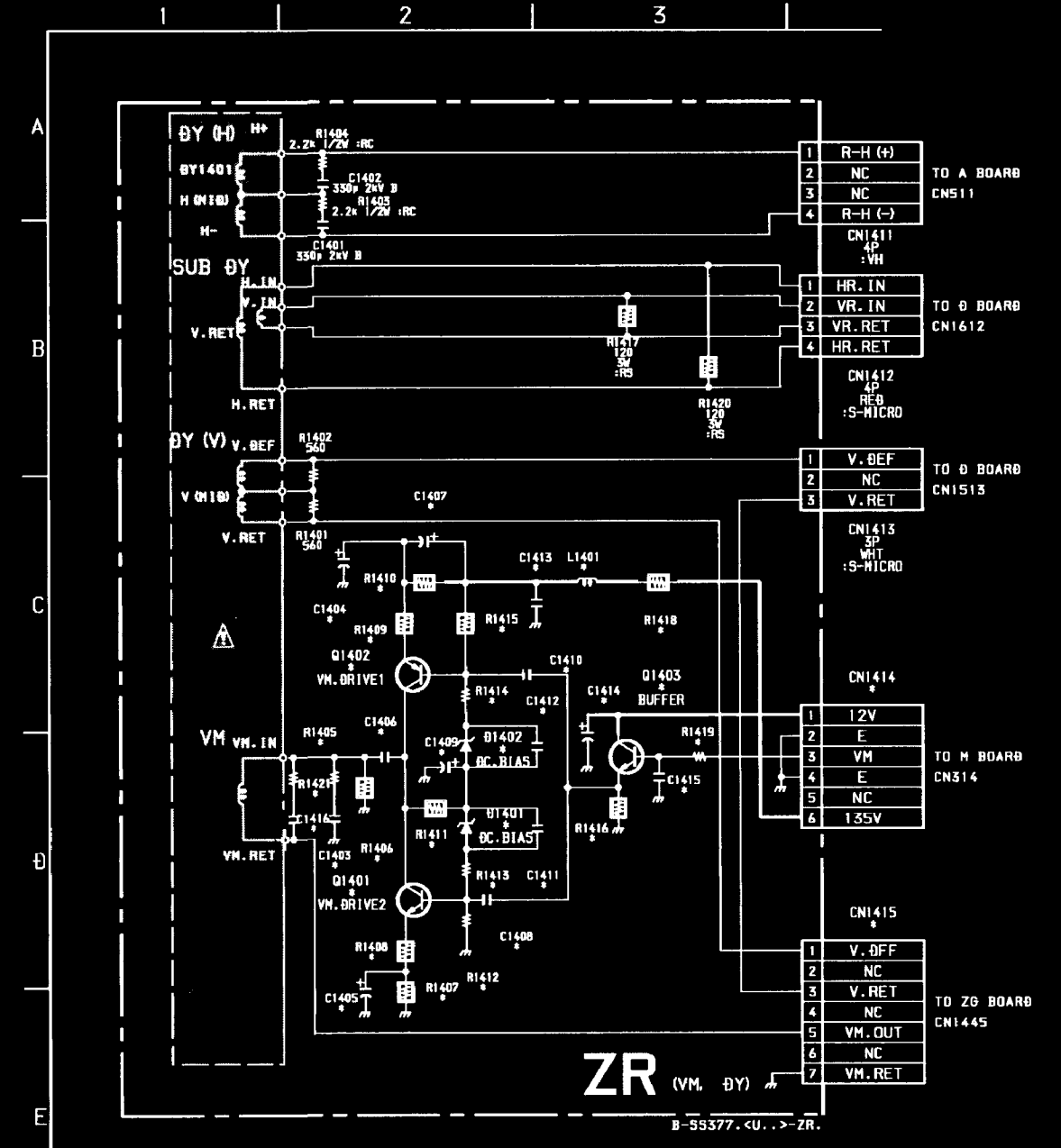

ZB

[VM, DY]

ZG

[VM, DY]

ZR

[VM, DY]

- ZB BOARD -

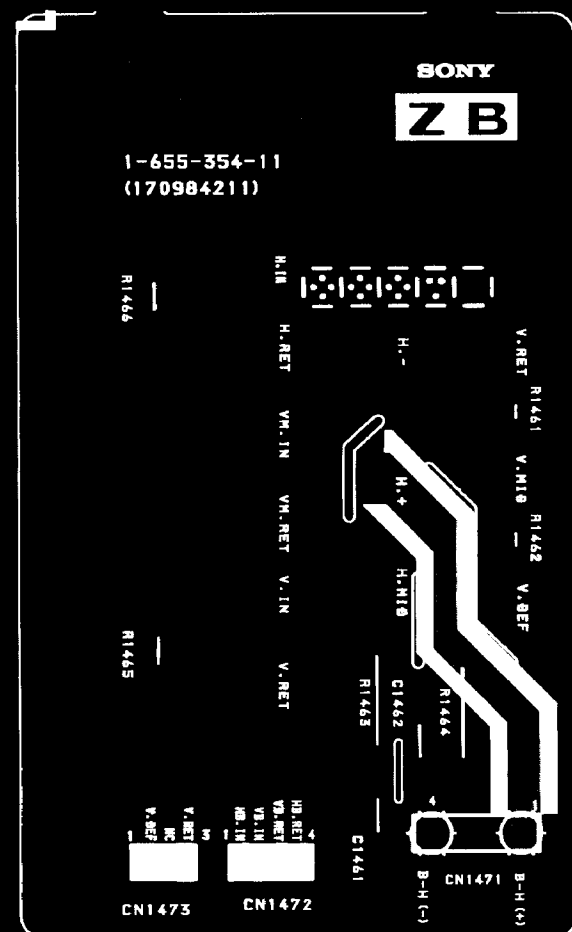

- ZG BOARD -

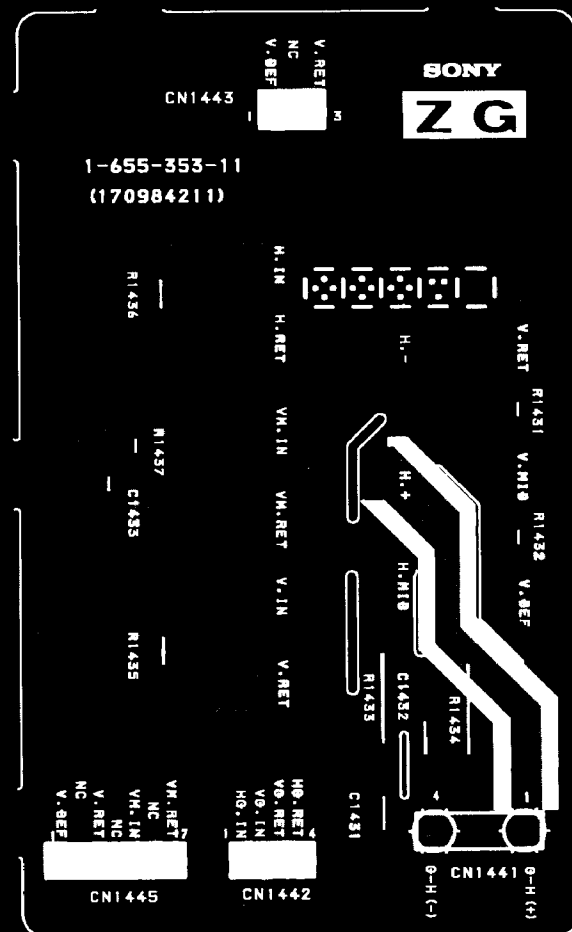

- ZR BOARD -

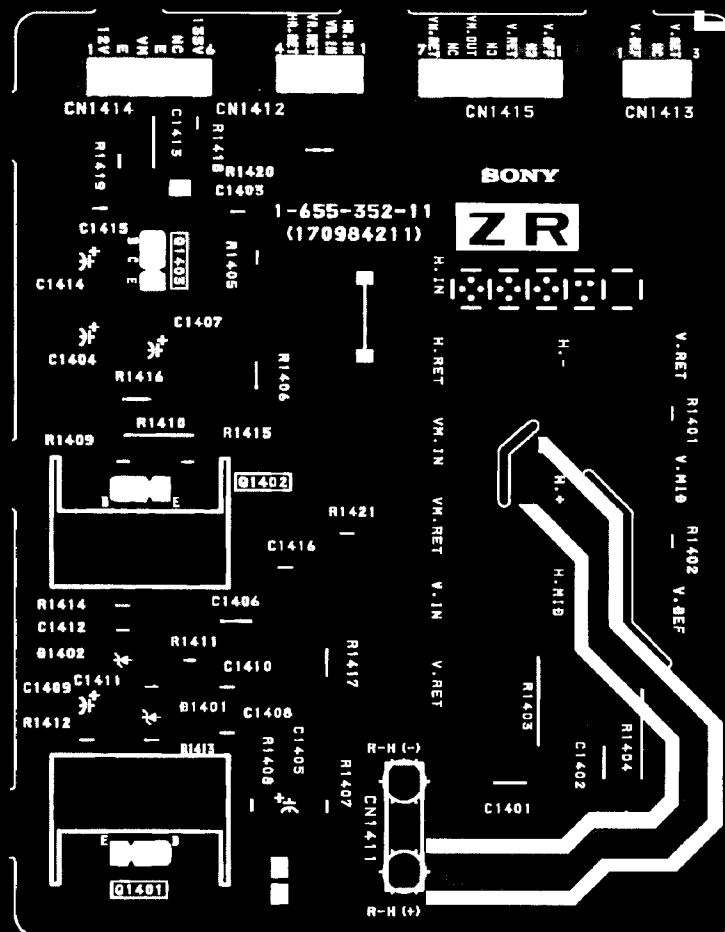

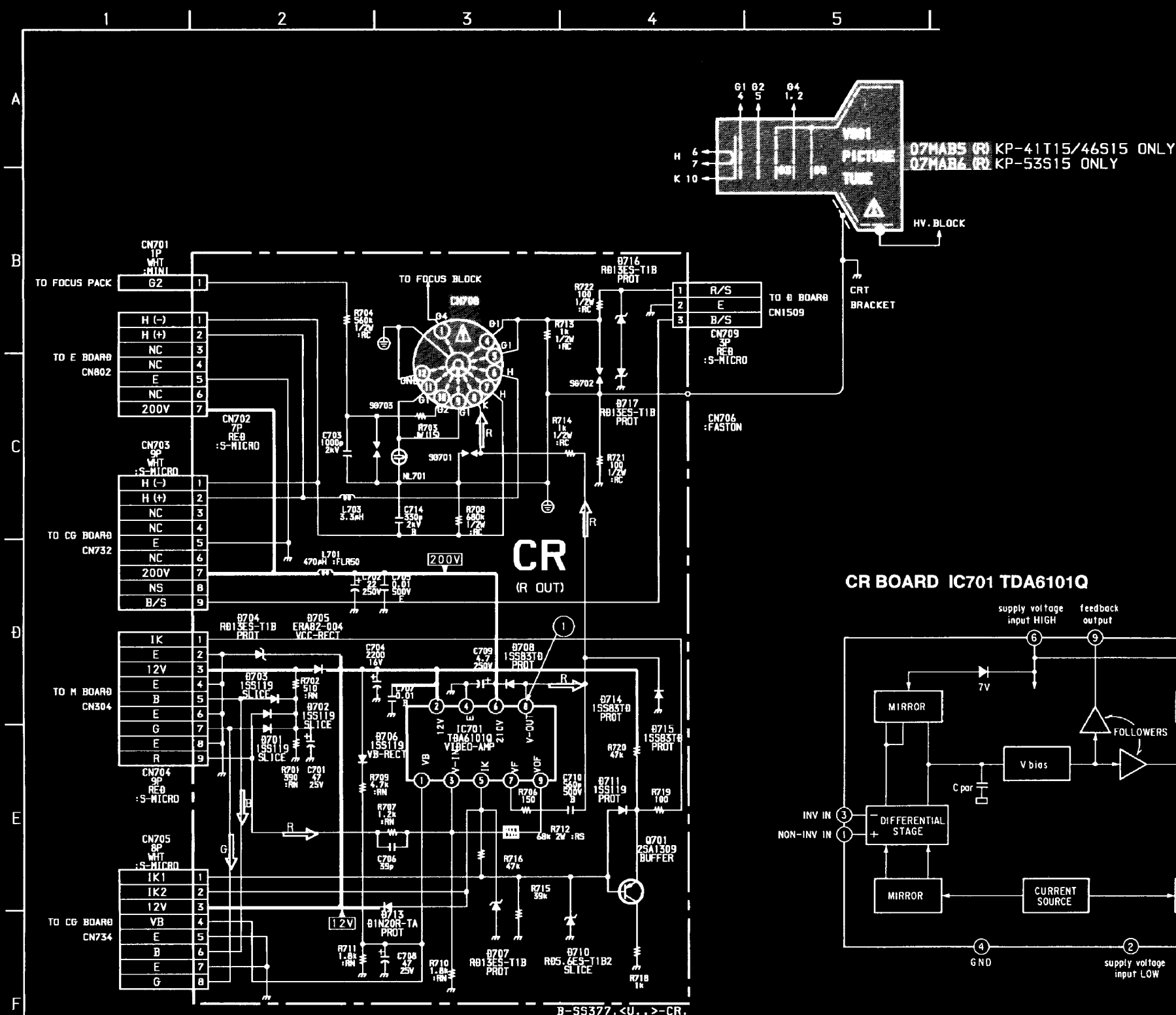

CR BOARD IC701 TDA6101Q

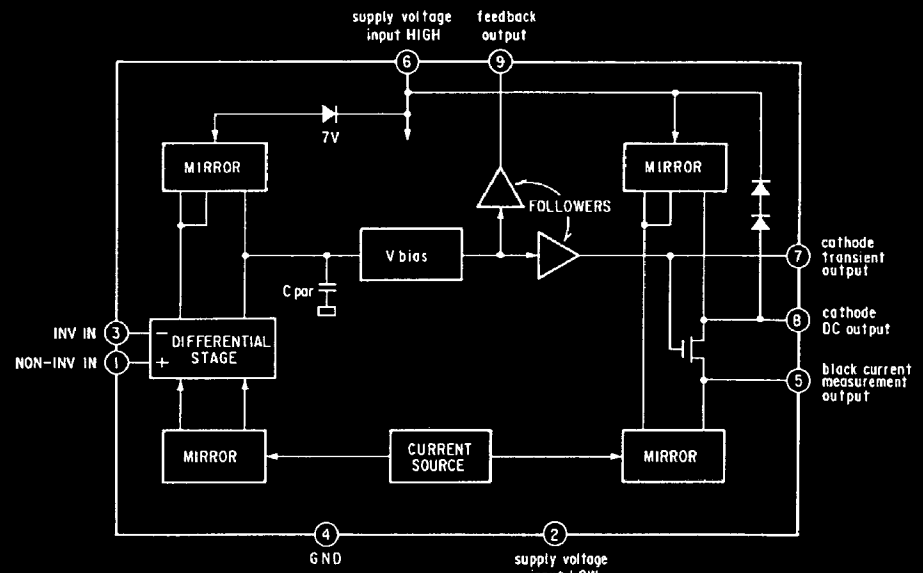

CR BOARD IC VOLTAGE LIST ALL VOLTAGES ARE IN V

IC701	1	3.2	3	3.0	5	8.2	7	171.5	9	170.1
	2	12.0	4	GND	6	200	8	171.6		

CR BOARD TRANSISTOR VOLTAGE LIST

	E	C	B
Q701	3.3	0.3	3.7

CR BOARD WAVEFORMS

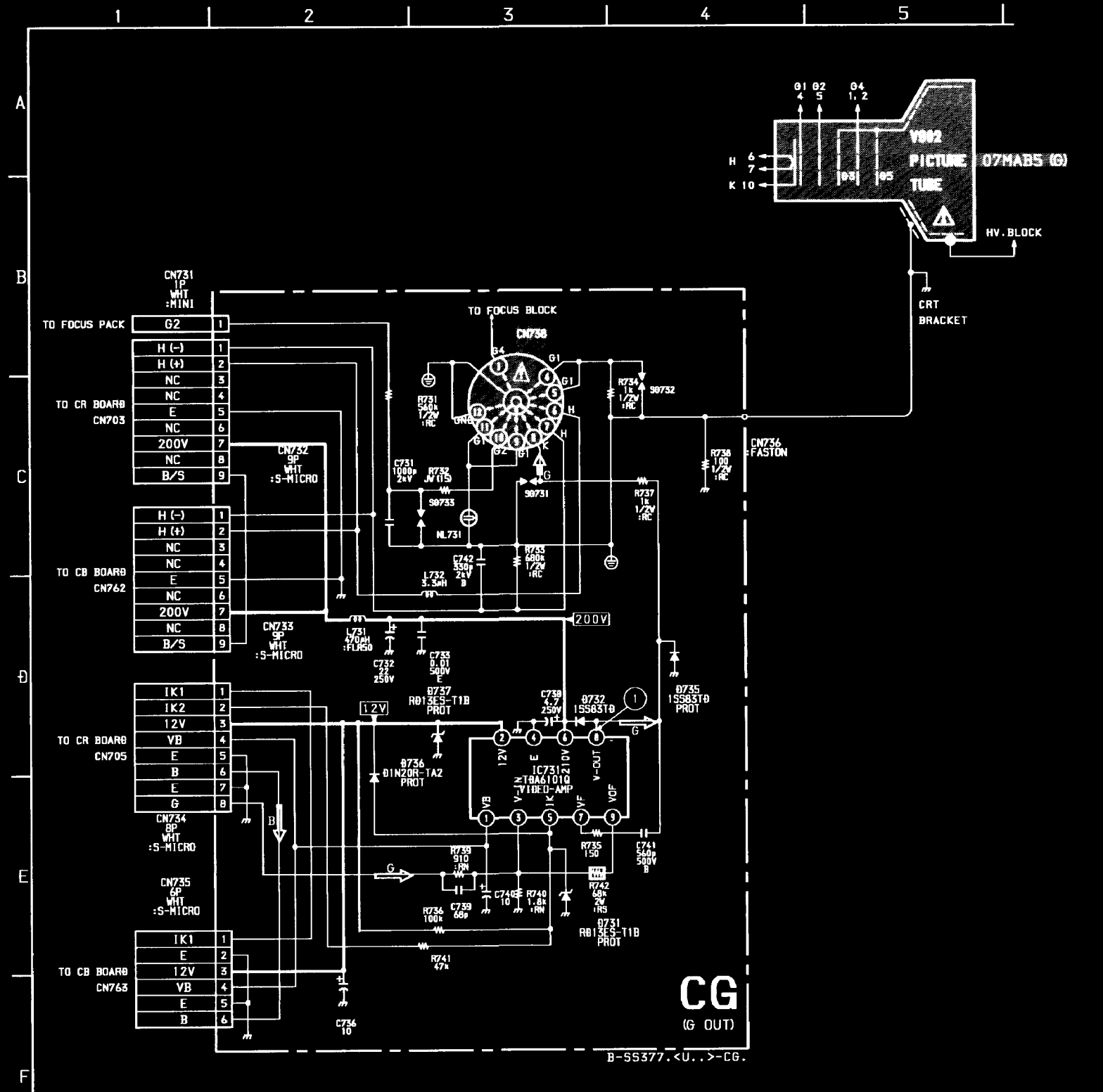
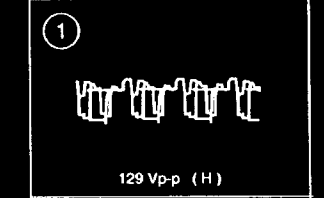

CG BOARD IC VOLTAGE LIST ALL VOLTAGES ARE IN V

IC731	1	3.1	3	2.9	5	9.6	7	173.8	9	172.4
	2	12.0	4	GND	6	200	8	175.4		

CG BOARD WAVEFORMS



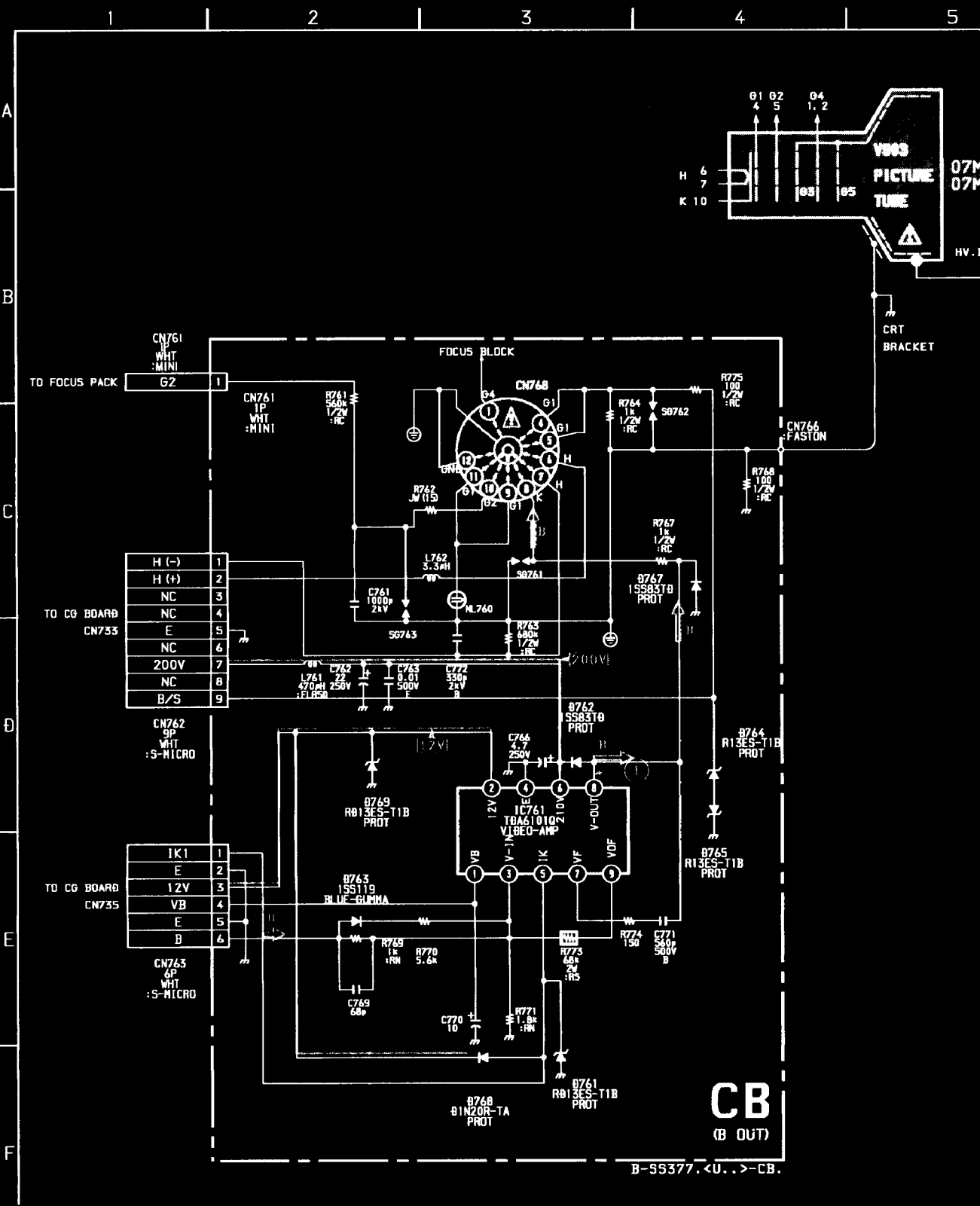

CB BOARD IC VOLTAGE LIST

ALL VOLTAGES ARE IN V

IC761	1 3.1	3 3.0	5 4.3	7 147.2	9 145.9
	2 12.0	4 GND	6 200	8 149.7	

• CB BOARD WAVEFORMS

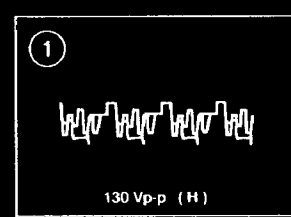

CR [R OUT] CG [G OUT] CB [B OUT]

- CR BOARD -

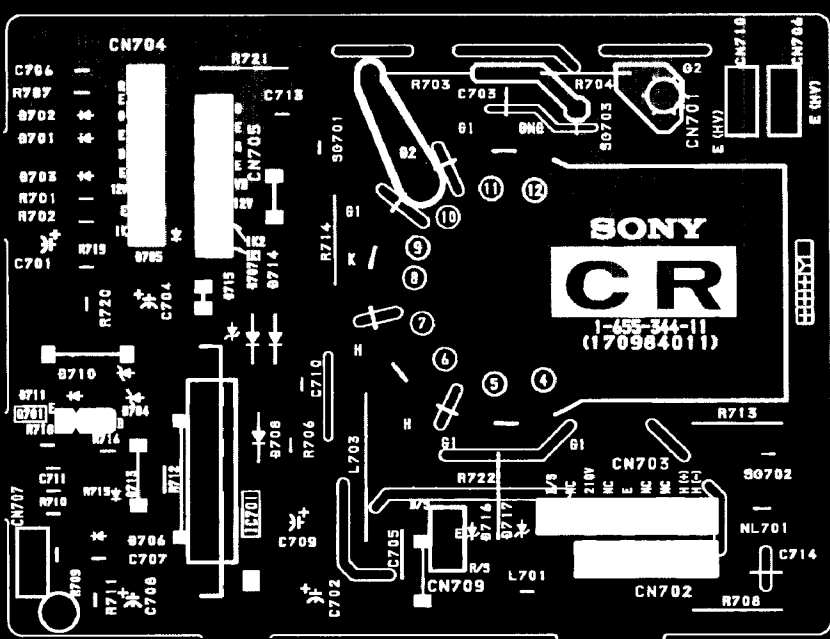

- CG BOARD -

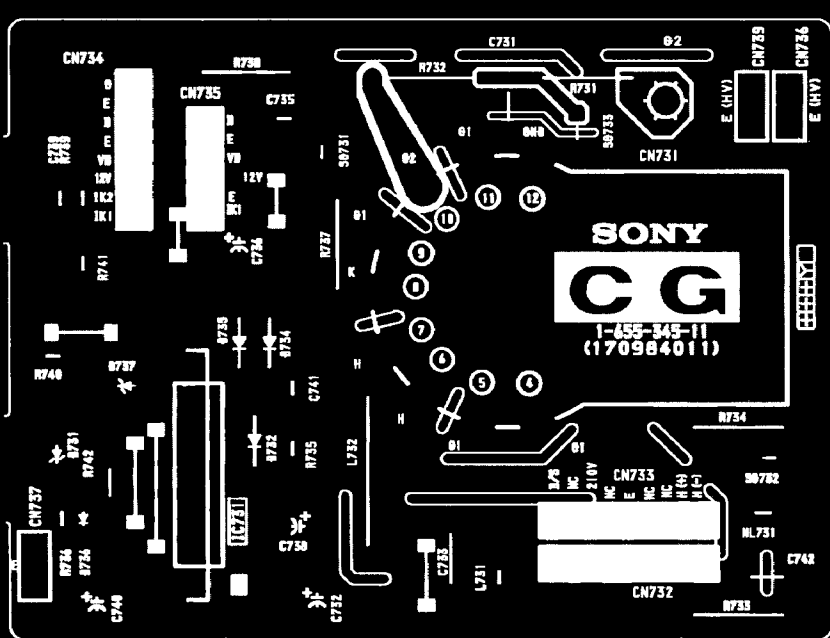

- CB BOARD -

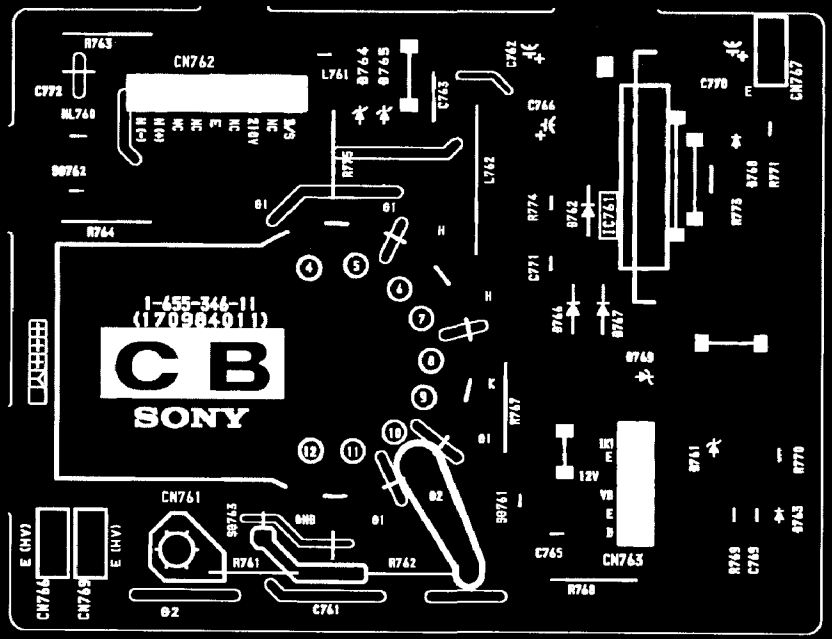

- CB BOARD -

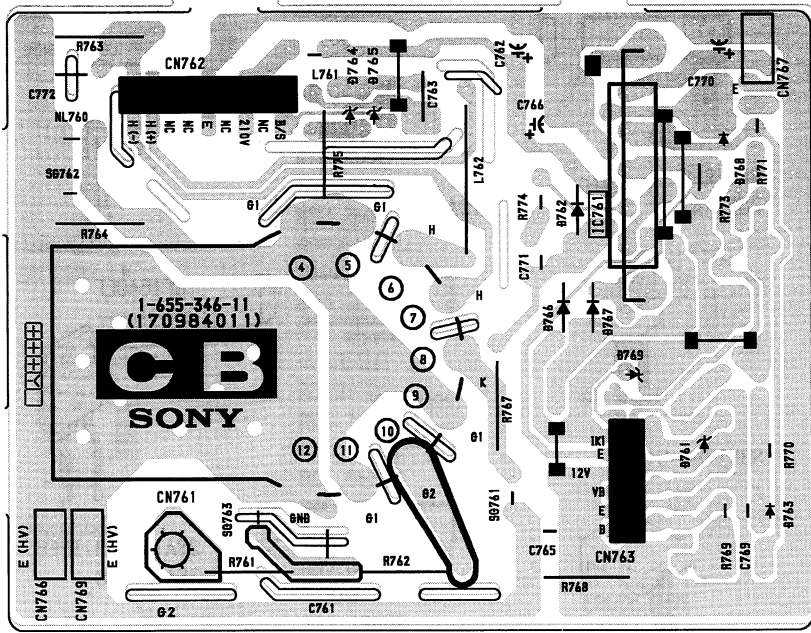

Schematic diagrams

← **CB** board

4-4. SEMICONDUCTORS

CAT51C262-ZS
MSM51C262-ZS

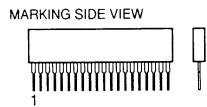

24pin SIP

CXA1477AS
CXA1855S

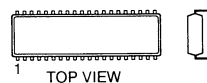

48pin DIP

CXP85112B-SX377
CXP85332A-SX377

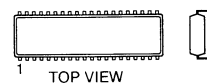

64pin DIP

LM7912CT
NJM7905FA
MC7905CT

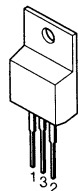

M5218AP
ST24C01CB1
ST24C04CB1
UPC358C

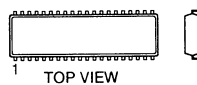

8pin DIP

MB3512PFQ

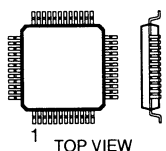

48pin QFP

MB40176PF-G-BND-EF

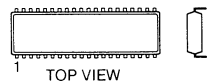

16pin DIP

MB86144BPF-G-BND

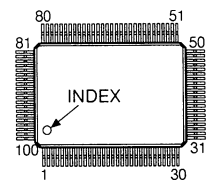

MN1280-S

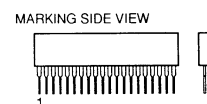

3pin SIP

MN1382S

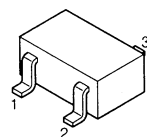

NJM2058D

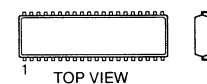

14pin DIP

NJM7805FA
NJM7812FA
NJM78M09FA
TA7805S
TA7812S

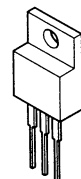

PA0053B
Z8622812PSC

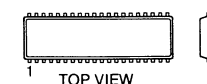

18pin DIP

PM0002B

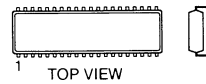

42pin DIP

PQ05RF1
PQ09RA1

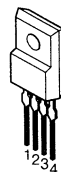

SBX1780-51

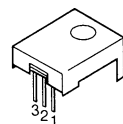

STK392-010

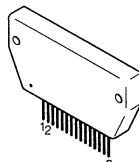

STV9379

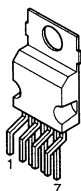

TC7SU04F

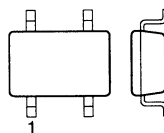

5pin CHIP

TDA6101Q

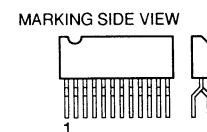

9pin ZIP

TDA7265

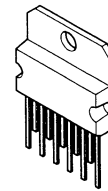

TDA8424

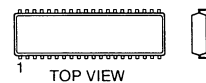

20pin DIP

UPC339C

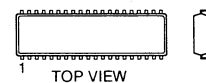

14pin DIP

UPC574J

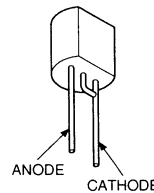

UPC78N05H

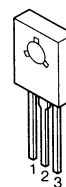

DTC124ES
2SC2458-YGR



DTC323TS
2SA1175-HFE
2SC2785-HFE

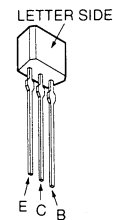

IRF1640LF

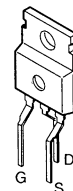

2SA1013-R-TPE6
2SA1208-S



2SA1162-G
2SC1623-L5L6
2SD601A-Q

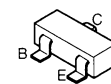

2SA1221-L
2SB733-34
2SD774-34

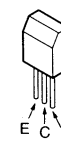

2SA1492M-OPY

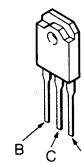

2SA1837
2SC4793
2SD2348(LBSONY-2)

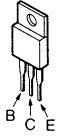

2SB649A-C
2SC2688-LK

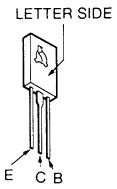

2SC2878-AB

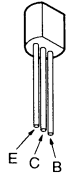

2SC4632LS-CB7
2SD1887-CA

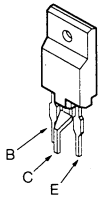

2SC4834M

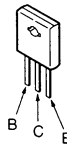

D10SBS4-F
D4SBS4-F
LN4SB60-F

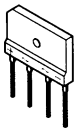

D1N20R
ERA85-009
ERC91-02TP11
RD10ESB2
RD11ESB2
RD13ESB2
RD15ESB2
RD18ESB2
RD2.0ESB2
RD2.2ESB2
RD22ESB3
RD24ESB
RD3.3ESB2
RD3.9ESB2
RD33ESB1
RD39ESB2
RD5.1ESB1
RD5.1ESB2
RD5.6ESB1
RD5.6ESB2
RD8.2ESB2
RD9.1ESL
11ES2
1SS119-25

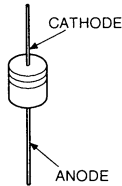

D1NL20
D1NL40-TR2
D2L40-TA
EL1Z
ERD28-08S
GP08D
RGP02-20EL-6394
1SS83

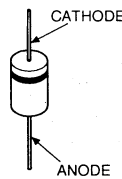

D2S4MF

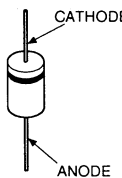

D8LC40-F



DAN202K

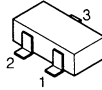

DAP202K

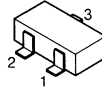

ERC06-15S
ERC91-02
RU-1C

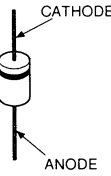

ERC38-06
V09G

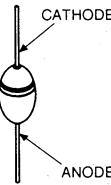

HVU359TRF
MA110
1T363

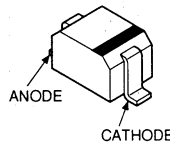

RD13M-B3
RD3.3M-B1
RD3.9M-B1
RD4.7M-B2
RD5.1M-B2
RD5.6M-B2

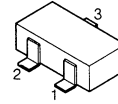

SLR-325VCT31

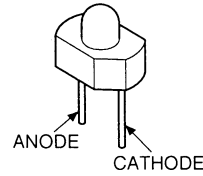

SECTION 5 EXPLODED VIEWS

NOTE :

- Items with on part number and on description are not stocked because they are seldom required for routine service.
- The construction parts of an assembled part are indicated with a collation number in the remark column.
- Items marked "*" are not stocked since they are seldom required for routine service. Some delay should be anticipated when ordering these items.

The components identified by shading and mark Δ are critical for safety. Replace only with part number specified.

Les composants identifiés par une trame et une marque Δ sont critiques pour la sécurité. Ne les remplacer que par une pièce portant le numéro spécifié.

5-1. COVER (KP-41T15)

- : 7-685-648-79 + BVTP 3×12
- : 7-685-663-79 + BVTP 4×16
- Δ : 7-685-660-79 + BVTP 4×10

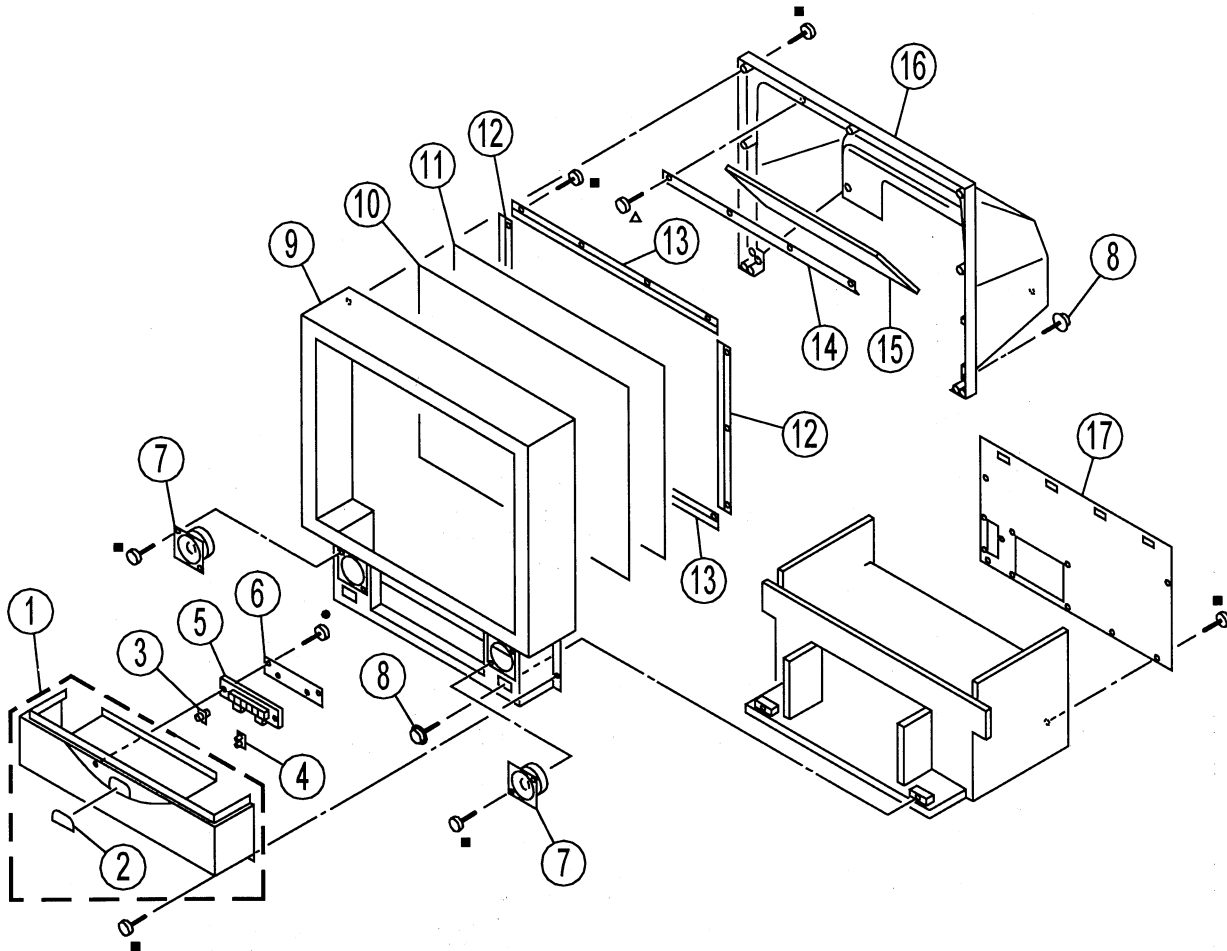

REF.NO.	PART NO.	DESCRIPTION	REMARK	REF.NO.	PART NO.	DESCRIPTION	REMARK
1	X-4032-545-1	PANEL ASSY, CONTROL					
2	4-048-000-01	DOOR, CONTROL	2	11	4-047-943-11	PLATE (F), DIFFUSION	
3	4-047-999-01	FILTER, REMOTE		12	4-036-092-01	HOLDER (S), SCREEN	
4	4-047-998-01	GUIDE, LIGHT, LED		13	4-036-091-31	HOLDER (L), SCREEN	
5	4-048-001-01	BUTTON, MULTI		14	*4-037-351-01	HOLDER, MIRROR	
6	*A-1372-099-A	HA BOARD, COMPLETE		15	4-047-861-01	MIRROR (41), REFLECTION	
7	1-504-785-11	SPEAKER (10CM)		16	*X-4032-607-1	COVER ASSY, MIRROR	
8	4-041-164-11	SCREW (4X20), TAPPING		17	*4-047-837-01	PLATE (41), REAR	
9	X-4032-546-1	BEZNET ASSY					
10	4-034-053-01	PLATE (L), DIFFUSION					

5-2. COVER (KP-46S15/53S15)

● : 7-685-648-79 + BVTP 3×12
 ■ : 7-685-663-79 + BVTP 4×16

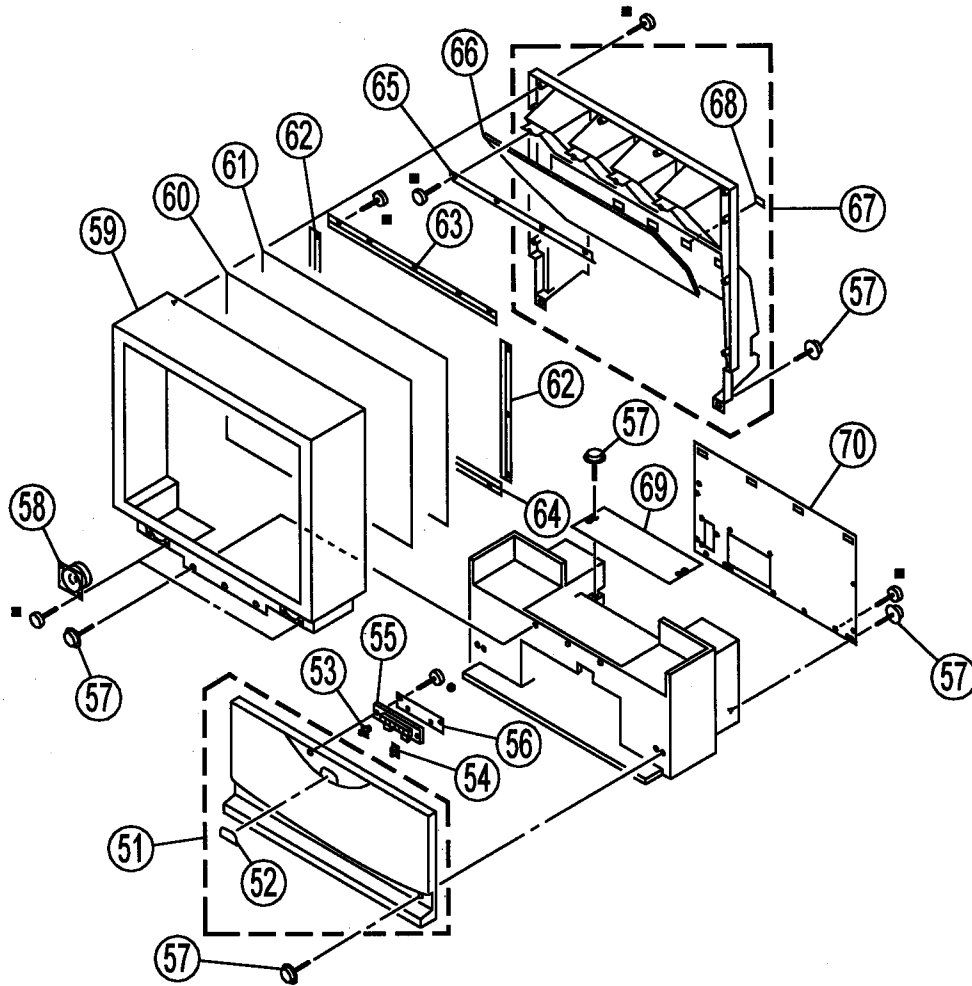

REF.NO.	PART NO.	DESCRIPTION	REMARK	REF.NO.	PART NO.	DESCRIPTION	REMARK		
51	X-4032-614-1	GRILLE ASSY, SPEAKER	152	64	*4-048-159-21	HOLDER (L), SCREEN (KP-46S15)			
52	4-048-000-01	DOOR, CONTROL		64	*4-048-159-31	HOLDER (L), SCREEN (KP-53S15)			
53	4-047-999-01	FILTER, REMOTE		65	4-036-092-01	HOLDER (S), SCREEN			
54	4-047-998-01	GUIDE, LIGHT, LED		66	4-048-181-01	MIRROR (53) (KP-53S15)			
55	4-048-001-01	BUTTON, MULTI		66	4-048-182-01	MIRROR (46'') (KP-46S15)			
56	*A-1372-099-A	HA BOARD, COMPLETE		67	*X-4032-619-1	COVER ASSY, MIRROR (KP-46S15)		168	
57	4-041-164-11	SCREW (4X20), TAPPING		67	*X-4032-620-1	COVER ASSY, MIRROR (KP-53S15)		168	
58	1-504-785-11	SPEAKER (10CM)		68	4-048-150-01	CAP, HOLE			
59	X-4032-617-1	BEZNET ASSY (KP-46S15)		69	*4-048-160-01	PLATE, SHIELD (KP-46S15)			
	X-4032-618-1	BEZNET ASSY (KP-53S15)		69	*4-048-161-01	PLATE, SHIELD (KP-53S15)			
60	4-036-466-11	PLATE (L), DIFFUSION (KP-53S15)			70	*4-048-168-01		PLATE, REAR (KP-53S15)	
	4-037-360-11	PLATE (L), DIFFUSION (KP-46S15)				*4-048-169-01		PLATE, REAR (KP-46S15)	
61	4-036-469-11	PLATE (F), DIFFUSION (KP-53S15)							
	4-048-205-11	PLATE (F), DIFFUSION (KP-46S15)							
62	*4-048-152-01	HOLDER (S), SCREEN (KP-46S15)							
	*4-048-152-11	HOLDER (S), SCREEN (KP-53S15)							
63	*4-048-159-01	HOLDER (L), SCREEN (KP-46S15)							
	*4-048-159-11	HOLDER (L), SCREEN (KP-53S15)							



Les composants identifiés par une trame et une marque Δ sont critiques pour la sécurité. Ne les remplacer que par une pièce portant le numéro spécifique.

The components identified by shading and mark Δ are critical for safety. Replace only with part number specified.

REF. NO.	PART NO.	DESCRIPTION	REMARK	REF. NO.	PART NO.	DESCRIPTION	REMARK
R995	1-216-677-11	METAL CHIP 12K 0.50% 1/10W		C1802	1-126-964-11	ELECT 10MF 20% 50V	
R996	1-208-814-11	METAL CHIP 22K 0.50% 1/10W		C1803	1-163-809-11	CERAMIC CHIP 0.047MF 10% 25V	
R997	1-216-065-00	METAL GLAZE 4.7K 5% 1/10W		C1805	1-163-809-11	CERAMIC CHIP 0.047MF 10% 25V	
R998	1-216-073-00	METAL GLAZE 10K 5% 1/10W		C1806	1-163-127-00	CERAMIC CHIP 270PF 5% 50V	
R999	1-216-051-00	METAL GLAZE 1.2K 5% 1/10W		C1807	1-163-809-11	CERAMIC CHIP 0.047MF 10% 25V	
<SPARK GAP>				C1808	1-163-809-11	CERAMIC CHIP 0.047MF 10% 25V	
SG801	1-519-422-11	GAP, SPARK		C1809	1-126-940-11	ELECT 330MF 20% 16V	
<TRANSFORMER>				C1810	1-126-940-11	ELECT 330MF 20% 16V	
T801	Δ 8-598-939-00	TRANSFORMER ASSY, FLYBACK (MX-2631/A4S)		C1811	1-163-809-11	CERAMIC CHIP 0.047MF 10% 25V	
T802	1-437-209-11	TRANSFORMER, HORIZONTAL DRIVE		C1812	1-163-809-11	CERAMIC CHIP 0.047MF 10% 25V	
T803	Δ 1-427-980-11	TRANSFORMER, FERRITE (LOT)		C1813	1-163-275-11	CERAMIC CHIP 0.001MF 5% 50V	
*****				C1814	1-163-809-11	CERAMIC CHIP 0.047MF 10% 25V	
*A-1346-296-A	D BOARD, COMPLETE	*****		C1816	1-163-117-00	CERAMIC CHIP 100PF 5% 50V	
4-382-854-11	SCREW (M3X10), P, SW (+)			C1817	1-163-117-00	CERAMIC CHIP 100PF 5% 50V	
<CAPACITOR>				C1818	1-163-809-11	CERAMIC CHIP 0.047MF 10% 25V	
C1502	1-126-768-11	ELECT 2200MF 20% 16V		C1819	1-124-903-11	ELECT 1MF 20% 50V	
C1503	1-164-232-11	CERAMIC CHIP 0.01MF 10% 50V		C1820	1-163-005-11	CERAMIC CHIP 470PF 10% 50V	
C1504	1-126-768-11	ELECT 2200MF 20% 16V		C1821	1-124-902-00	ELECT 0.47MF 20% 50V	
C1505	1-136-177-00	FILM 1MF 5% 50V		C1822	1-163-005-11	CERAMIC CHIP 470PF 10% 50V	
C1506	1-102-228-00	CERAMIC 470PF 10% 500V		C1823	1-124-903-11	ELECT 1MF 20% 50V	
C1507	1-164-232-11	CERAMIC CHIP 0.01MF 10% 50V		C1824	1-124-903-11	ELECT 1MF 20% 50V	
C1508	1-163-117-00	CERAMIC CHIP 100PF 5% 50V		C1825	1-126-967-11	ELECT 47MF 20% 50V	
C1509	1-124-122-11	ELECT 100MF 20% 50V		C1826	1-126-967-11	ELECT 47MF 20% 50V	
C1510	1-137-398-11	FILM 0.068MF 10% 100V		C1827	1-163-809-11	CERAMIC CHIP 0.047MF 10% 25V	
C1511	1-137-423-11	FILM 0.15MF 10% 100V		C1828	1-163-809-11	CERAMIC CHIP 0.047MF 10% 25V	
C1512	1-137-423-11	FILM 0.15MF 10% 100V		C1829	1-163-809-11	CERAMIC CHIP 0.047MF 10% 25V	
C1513	1-163-109-00	CERAMIC CHIP 47PF 5% 50V		C1830	1-163-809-11	CERAMIC CHIP 0.047MF 10% 25V	
C1514	1-163-031-11	CERAMIC CHIP 0.01MF 50V		C1831	1-126-940-11	ELECT 330MF 20% 16V	
C1515	1-163-031-11	CERAMIC CHIP 0.01MF 50V		C1832	1-126-940-11	ELECT 330MF 20% 16V	
C1516	1-136-177-00	FILM 1MF 5% 50V		C1833	1-163-809-11	CERAMIC CHIP 0.047MF 10% 25V	
C1517	1-163-125-00	CERAMIC CHIP 220PF 5% 50V		C1834	1-163-809-11	CERAMIC CHIP 0.047MF 10% 25V	
C1551	1-126-964-11	ELECT 10MF 20% 50V		C1835	1-163-809-11	CERAMIC CHIP 0.047MF 10% 25V	
C1603	1-163-117-00	CERAMIC CHIP 100PF 5% 50V		C1836	1-163-809-11	CERAMIC CHIP 0.047MF 10% 25V	
C1604	1-163-117-00	CERAMIC CHIP 100PF 5% 50V		C1837	1-164-489-11	CERAMIC CHIP 0.22MF 10% 16V	
C1605	1-163-117-00	CERAMIC CHIP 100PF 5% 50V		C1838	1-124-122-11	ELECT 100MF 20% 50V	
C1606	1-163-117-00	CERAMIC CHIP 100PF 5% 50V		C1839	1-124-122-11	ELECT 100MF 20% 50V	
C1607	1-163-117-00	CERAMIC CHIP 100PF 5% 50V		C1840	1-124-903-11	ELECT 1MF 20% 50V	
C1608	1-163-117-00	CERAMIC CHIP 100PF 5% 50V		C1841	1-126-967-11	ELECT 47MF 20% 50V	
C1611	1-124-122-11	ELECT 100MF 20% 50V		C1842	1-163-117-00	CERAMIC CHIP 100PF 5% 50V	
C1612	1-104-665-11	ELECT 100MF 20% 25V		C1843	1-163-117-00	CERAMIC CHIP 100PF 5% 50V	
C1613	1-124-122-11	ELECT 100MF 20% 50V		C1844	1-126-967-11	ELECT 47MF 20% 50V	
C1615	1-104-665-11	ELECT 100MF 20% 25V		C1845	1-163-809-11	CERAMIC CHIP 0.047MF 10% 25V	
C1617	1-126-967-11	ELECT 47MF 20% 50V		C1846	1-163-809-11	CERAMIC CHIP 0.047MF 10% 25V	
C1619	1-104-664-11	ELECT 47MF 20% 25V		C1847	1-163-809-11	CERAMIC CHIP 0.047MF 10% 25V	
C1620	1-126-967-11	ELECT 47MF 20% 50V		C1848	1-163-809-11	CERAMIC CHIP 0.047MF 10% 25V	
C1622	1-104-664-11	ELECT 47MF 20% 25V		C1849	1-124-122-11	ELECT 100MF 20% 50V	
C1701	1-126-935-11	ELECT 470MF 20% 16V		C1850	1-124-122-11	ELECT 100MF 20% 50V	
C1702	1-163-809-11	CERAMIC CHIP 0.047MF 10% 25V		C1851	1-137-399-11	FILM 0.1MF 5% 50V	
C1703	1-163-099-00	CERAMIC CHIP 18PF 5% 50V		C1852	1-124-122-11	ELECT 100MF 20% 50V	
C1704	1-163-125-00	CERAMIC CHIP 220PF 5% 50V		C1853	1-137-378-11	FILM 0.22MF 5% 50V	
C1705	1-163-099-00	CERAMIC CHIP 18PF 5% 50V		C1854	1-124-927-11	ELECT 4.7MF 20% 50V	
C1709	1-163-031-11	CERAMIC CHIP 0.01MF 50V		C1855	1-124-903-11	ELECT 1MF 20% 50V	
C1723	1-163-117-00	CERAMIC CHIP 100PF 5% 50V		C1856	1-104-665-11	ELECT 100MF 20% 25V	
C1724	1-163-117-00	CERAMIC CHIP 100PF 5% 50V		C1857	1-124-122-11	ELECT 100MF 20% 50V	
C1801	1-124-903-11	ELECT 1MF 20% 50V		C1858	1-163-809-11	CERAMIC CHIP 0.047MF 10% 25V	
C1859	1-163-809-11	CERAMIC CHIP 0.047MF 10% 25V		C1859	1-163-809-11	CERAMIC CHIP 0.047MF 10% 25V	
C1860	1-163-809-11	CERAMIC CHIP 0.047MF 10% 25V		C1860	1-163-809-11	CERAMIC CHIP 0.047MF 10% 25V	
C1861	1-124-122-11	ELECT 100MF 20% 50V		C1861	1-124-122-11	ELECT 100MF 20% 50V	
C1862	1-124-903-11	ELECT 1MF 20% 50V		C1862	1-124-903-11	ELECT 1MF 20% 50V	
C1863	1-136-173-00	FILM 0.47MF 5% 50V		C1863	1-136-173-00	FILM 0.47MF 5% 50V	
C1864	1-124-903-11	ELECT 1MF 20% 50V		C1864	1-124-903-11	ELECT 1MF 20% 50V	
C1865	1-124-903-11	ELECT 1MF 20% 50V		C1865	1-124-903-11	ELECT 1MF 20% 50V	
C1866	1-126-967-11	ELECT 47MF 20% 50V		C1866	1-126-967-11	ELECT 47MF 20% 50V	

The components identified by shading and mark Δ are critical for safety. Replace only with part number specified.

Les composants identifiés par une trame et une marque Δ sont critiques pour la sécurité. Ne les remplacer que par une pièce portant le numéro spécifié.



REF. NO.	PART NO.	DESCRIPTION	REMARK	REF. NO.	PART NO.	DESCRIPTION	REMARK
<CONDUCTOR CHIP>							
CJ1	1-216-295-00	CONDUCTOR, CHIP		CN1716*1-564-507-11	PLUG, CONNECTOR 4P		
CJ2	1-216-295-00	CONDUCTOR, CHIP		CN1756*1-564-508-11	PLUG, CONNECTOR 5P		
CJ3	1-216-295-00	CONDUCTOR, CHIP		CN1757*1-564-516-11	PLUG, CONNECTOR 13P		
CJ4	1-216-295-00	CONDUCTOR, CHIP		<DIODE>			
CJ5	1-216-295-00	CONDUCTOR, CHIP		D1501	8-719-908-03	DIODE GP08D	
CJ6	1-216-295-00	CONDUCTOR, CHIP		D1502	8-719-109-89	DIODE RD5.6ESB2	
CJ7	1-216-295-00	CONDUCTOR, CHIP		D1503	8-719-908-03	DIODE GP08D	
CJ8	1-216-295-00	CONDUCTOR, CHIP		D1505	8-719-109-88	DIODE RD5.6ESB1	
CJ9	1-216-295-00	CONDUCTOR, CHIP		D1551	8-719-109-72	DIODE RD3.9ESB2	
CJ10	1-216-295-00	CONDUCTOR, CHIP		D1552	8-719-911-19	DIODE 1SS119-25	
CJ11	1-216-295-00	CONDUCTOR, CHIP		D1553	8-719-911-19	DIODE 1SS119-25	
CJ12	1-216-295-00	CONDUCTOR, CHIP		D1601	8-719-908-03	DIODE GP08D	
CJ13	1-216-295-00	CONDUCTOR, CHIP		D1602	8-719-908-03	DIODE GP08D	
CJ16	1-216-295-00	CONDUCTOR, CHIP		D1603	8-719-908-03	DIODE GP08D	
CJ17	1-216-295-00	CONDUCTOR, CHIP		D1604	8-719-908-03	DIODE GP08D	
CJ18	1-216-295-00	CONDUCTOR, CHIP		D1803	8-719-911-19	DIODE 1SS119-25	
CJ19	1-216-295-00	CONDUCTOR, CHIP		D1812	8-719-911-19	DIODE 1SS119-25	
CJ20	1-216-295-00	CONDUCTOR, CHIP		D1814	8-719-911-19	DIODE 1SS119-25	
CJ21	1-216-295-00	CONDUCTOR, CHIP		D1825	8-719-911-19	DIODE 1SS119-25	
CJ22	1-216-295-00	CONDUCTOR, CHIP		D1826	8-719-911-19	DIODE 1SS119-25	
CJ23	1-216-295-00	CONDUCTOR, CHIP		D1827	8-719-109-68	DIODE RD3.6ESB1	
CJ24	1-216-295-00	CONDUCTOR, CHIP		D1931	8-719-110-60	DIODE RD24ESB	
CJ25	1-216-295-00	CONDUCTOR, CHIP		D1932	8-719-110-60	DIODE RD24ESB	
CJ26	1-216-295-00	CONDUCTOR, CHIP		D1934	8-719-110-60	DIODE RD24ESB	
CJ27	1-216-295-00	CONDUCTOR, CHIP		D1935	8-719-110-60	DIODE RD24ESB	
CJ28	1-216-295-00	CONDUCTOR, CHIP		D1936	8-719-110-60	DIODE RD24ESB	
CJ29	1-216-295-00	CONDUCTOR, CHIP		D1937	8-719-110-60	DIODE RD24ESB	
CJ30	1-216-295-00	CONDUCTOR, CHIP		D1942	8-719-110-60	DIODE RD24ESB	
CJ31	1-216-295-00	CONDUCTOR, CHIP		D1945	8-719-110-60	DIODE RD24ESB	
CJ34	1-216-295-00	CONDUCTOR, CHIP		D1946	8-719-110-60	DIODE RD24ESB	
CJ35	1-216-295-00	CONDUCTOR, CHIP		D1947	8-719-110-60	DIODE RD24ESB	
CJ36	1-216-295-00	CONDUCTOR, CHIP		D1948	8-719-110-36	DIODE RD13ESB2	
CJ37	1-216-295-00	CONDUCTOR, CHIP		D1949	8-719-110-60	DIODE RD24ESB	
CJ38	1-216-295-00	CONDUCTOR, CHIP		D1951	8-719-110-36	DIODE RD13ESB2	
CJ39	1-216-295-00	CONDUCTOR, CHIP		D1953	8-719-110-36	DIODE RD13ESB2	
CJ42	1-216-295-00	CONDUCTOR, CHIP		D1954	8-719-110-36	DIODE RD13ESB2	
CJ43	1-216-295-00	CONDUCTOR, CHIP		<FUSE>			
CJ44	1-216-295-00	CONDUCTOR, CHIP		F1601A	1-532-745-11	FUSE, GLASS TUBE (3.15A/125V)	
CJ45	1-216-295-00	CONDUCTOR, CHIP			1-533-223-11	HOLDER, FUSE; F1601	
CJ46	1-216-295-00	CONDUCTOR, CHIP		F1602A	1-532-745-11	FUSE, GLASS TUBE (3.15A/125V)	
CJ47	1-216-295-00	CONDUCTOR, CHIP			1-533-223-11	HOLDER, FUSE; F1602	
CJ48	1-216-295-00	CONDUCTOR, CHIP		<IC>			
CJ50	1-216-295-00	CONDUCTOR, CHIP		IC1501	8-759-192-71	IC STV9379	
CJ51	1-216-295-00	CONDUCTOR, CHIP		IC1601	8-749-010-88	IC STK392-010	
CJ53	1-216-295-00	CONDUCTOR, CHIP		IC1602	8-749-010-88	IC STK392-010	
CJ54	1-216-295-00	CONDUCTOR, CHIP		IC1701	8-752-861-57	IC CXP85112B-613S	
CJ55	1-216-295-00	CONDUCTOR, CHIP		IC1702	8-759-041-54	IC MN1382S	
CJ57	1-216-295-00	CONDUCTOR, CHIP		IC1801	8-759-327-52	IC PM0002B	
CJ58	1-216-295-00	CONDUCTOR, CHIP		IC1802	8-759-327-51	IC PA0053B	
CJ59	1-216-295-00	CONDUCTOR, CHIP		IC1803	8-759-012-67	IC MC7905CT	
CJ60	1-216-295-00	CONDUCTOR, CHIP		IC1804	8-759-231-53	IC TA7805S	
CJ62	1-216-295-00	CONDUCTOR, CHIP		IC1805	8-759-327-52	IC PM0002B	
CJ63	1-216-295-00	CONDUCTOR, CHIP		IC1806	8-759-327-51	IC PA0053B	
<CONNECTOR>				IC1807	8-759-929-65	IC LM7912CT	
CN1509*1-564-506-11	PLUG, CONNECTOR 3P			IC1808	8-759-701-79	IC NJM7812FA	
CN1513*1-564-506-11	PLUG, CONNECTOR 3P			IC1809	8-759-327-52	IC PM0002B	
CN1612*1-564-507-11	PLUG, CONNECTOR 4P			IC1931	8-759-711-28	IC NJM2058D	
CN1642*1-564-507-11	PLUG, CONNECTOR 4P			IC1932	8-759-711-28	IC NJM2058D	
CN1672*1-564-507-11	PLUG, CONNECTOR 4P						